

# **User Manual**



## **MTS300 MPEG Test System MPEG-2 DVB/ATSC/ISDB-S/ARIB System Analyzer 071-0659-01**

This document applies to MPEG Test System  
version 6.0 firmware and above.

**[www.tektronix.com](http://www.tektronix.com)**

Copyright © Tektronix, Inc. All rights reserved. Licensed software products are owned by Tektronix or its suppliers and are protected by United States copyright laws and international treaty provisions.

Use, duplication, or disclosure by the Government is subject to restrictions as set forth in subparagraph (c)(1)(ii) of the Rights in Technical Data and Computer Software clause at DFARS 252.227-7013, or subparagraphs (c)(1) and (2) of the Commercial Computer Software - Restricted Rights clause at FAR 52.227-19, as applicable.

Tektronix products are covered by U.S. and foreign patents, issued and pending. Information in this publication supercedes that in all previously published material. Specifications and price change privileges reserved.

Tektronix, Inc., P.O. Box 500, Beaverton, OR 97077

TEKTRONIX and TEK are registered trademarks of Tektronix, Inc.

## Hardware Warranty

Tektronix warrants that the products that it manufactures and sells will be free from defects in materials and workmanship for a period of one (1) year from the date of shipment. If a product proves defective during this warranty period, Tektronix, at its option, either will repair the defective product without charge for parts and labor, or will provide a replacement in exchange for the defective product.

In order to obtain service under this warranty, Customer must notify Tektronix of the defect before the expiration of the warranty period and make suitable arrangements for the performance of service. Customer shall be responsible for packaging and shipping the defective product to the service center designated by Tektronix, with shipping charges prepaid. Tektronix shall pay for the return of the product to Customer if the shipment is to a location within the country in which the Tektronix service center is located. Customer shall be responsible for paying all shipping charges, duties, taxes, and any other charges for products returned to any other locations.

This warranty shall not apply to any defect, failure or damage caused by improper use or improper or inadequate maintenance and care. Tektronix shall not be obligated to furnish service under this warranty a) to repair damage resulting from attempts by personnel other than Tektronix representatives to install, repair or service the product; b) to repair damage resulting from improper use or connection to incompatible equipment; c) to repair any damage or malfunction caused by the use of non-Tektronix supplies; or d) to service a product that has been modified or integrated with other products when the effect of such modification or integration increases the time or difficulty of servicing the product.

**THIS WARRANTY IS GIVEN BY TEKTRONIX IN LIEU OF ANY OTHER WARRANTIES, EXPRESS OR IMPLIED. TEKTRONIX AND ITS VENDORS DISCLAIM ANY IMPLIED WARRANTIES OF MERCHANTABILITY OR FITNESS FOR A PARTICULAR PURPOSE. TEKTRONIX' RESPONSIBILITY TO REPAIR OR REPLACE DEFECTIVE PRODUCTS IS THE SOLE AND EXCLUSIVE REMEDY PROVIDED TO THE CUSTOMER FOR BREACH OF THIS WARRANTY. TEKTRONIX AND ITS VENDORS WILL NOT BE LIABLE FOR ANY INDIRECT, SPECIAL, INCIDENTAL, OR CONSEQUENTIAL DAMAGES IRRESPECTIVE OF WHETHER TEKTRONIX OR THE VENDOR HAS ADVANCE NOTICE OF THE POSSIBILITY OF SUCH DAMAGES.**

## **Software Warranty**

Tektronix warrants that the media on which this software product is furnished and the encoding of the programs on the media will be free from defects in materials and workmanship for a period of three (3) months from the date of shipment. If a medium or encoding proves defective during the warranty period, Tektronix will provide a replacement in exchange for the defective medium. Except as to the media on which this software product is furnished, this software product is provided "as is" without warranty of any kind, either express or implied. Tektronix does not warrant that the functions contained in this software product will meet Customer's requirements or that the operation of the programs will be uninterrupted or error-free.

In order to obtain service under this warranty, Customer must notify Tektronix of the defect before the expiration of the warranty period. If Tektronix is unable to provide a replacement that is free from defects in materials and workmanship within a reasonable time thereafter, Customer may terminate the license for this software product and return this software product and any associated materials for credit or refund.

**THIS WARRANTY IS GIVEN BY TEKTRONIX IN LIEU OF ANY OTHER WARRANTIES, EXPRESS OR IMPLIED. TEKTRONIX AND ITS VENDORS DISCLAIM ANY IMPLIED WARRANTIES OF MERCHANTABILITY OR FITNESS FOR A PARTICULAR PURPOSE. TEKTRONIX' RESPONSIBILITY TO REPLACE DEFECTIVE MEDIA OR REFUND CUSTOMER'S PAYMENT IS THE SOLE AND EXCLUSIVE REMEDY PROVIDED TO THE CUSTOMER FOR BREACH OF THIS WARRANTY. TEKTRONIX AND ITS VENDORS WILL NOT BE LIABLE FOR ANY INDIRECT, SPECIAL, INCIDENTAL, OR CONSEQUENTIAL DAMAGES IRRESPECTIVE OF WHETHER TEKTRONIX OR THE VENDOR HAS ADVANCE NOTICE OF THE POSSIBILITY OF SUCH DAMAGES.**

# Table of Contents

<b>List of Tables</b> .....	<b>iii</b>
<b>General Safety Summary</b> .....	<b>v</b>
<b>Preface</b> .....	<b>vii</b>
Manual Structure .....	vii
Symbols and Terms .....	viii
Related Documents .....	viii
Related Applications .....	ix
Software Version .....	xii
Contacting Tektronix .....	xiii

## Getting Started

Requirements .....	1-1
Logging On .....	1-2
Installing Software .....	1-3
Entering the License Password .....	1-6
Running the Software .....	1-8
Software Repair .....	1-9

## Operating Basics

Deferred-Time Analysis .....	2-1
Acquiring Transport Stream and Elementary Stream Files .....	2-3
<b>Tutorial: Analyzing a Transport Stream</b> .....	<b>2-7</b>
Getting Help .....	2-7
Starting the Analyzer Application .....	2-8
The Application Window .....	2-8
Opening an Existing Transport Stream File .....	2-11
The Hierarchic View .....	2-12
Exploring the TS Icon .....	2-15
Exploring the Transport Packet Icon .....	2-22
Exploring the PAT Icon .....	2-24
Exploring the PMT Icon .....	2-26
Exploring the PES Packet Icon .....	2-32
Viewing PSI/SI Data .....	2-38
Automatic Analysis .....	2-40
Quitting the Analyzer .....	2-44

## Reference

<b>MPEG-2 DVB/ATSC/ISDB-S/ARIB System Analyzer</b> .....	<b>3-1</b>
Overview .....	3-1
The Application Window .....	3-3
The Escape Key .....	3-13
Opening a File .....	3-14
The Hierarchic View .....	3-15
The Interpreted View .....	3-23
Hexadecimal and Binary Views .....	3-27

Multiplex Analyses .....	3-29
Check CRC .....	3-31
Syntactic Analysis .....	3-33
Consistency Check .....	3-34
PSI/SI/ISDB-S/PSIP Rate Analysis .....	3-37
Timing Analyses .....	3-38
Semantic Analysis .....	3-45
Mega-frame (MIP) Analysis .....	3-46
Dynamic Analyses .....	3-47
Automatic Analysis .....	3-54
Filters .....	3-56
Extracting and Saving Stream Elements .....	3-65
The Options Menu .....	3-68
Message Window .....	3-72
<b>Option CA .....</b>	<b>3-77</b>
Activating Option CA .....	3-77
Unscrambling with the MPEG-2 System Analyzer .....	3-78
EMM Analysis .....	3-82
<b>DVB Channel Coding and Decoding .....</b>	<b>3-95</b>
Starting the Application .....	3-96
Menu Commands .....	3-97
Coding Types .....	3-107
<b>TMCC Expert Client Reference .....</b>	<b>3-111</b>
Using the TMCC Expert Client Display Elements .....	3-112
Using the TMCC Deferred-Time Client .....	3-118
TMCC Probe Descriptions .....	3-128

## Appendices

<b>Appendix A: What to Do if an Application Locks Up .....</b>	<b>A-1</b>
<b>Appendix B: Software Repair .....</b>	<b>B-1</b>
Reinstalling the MTS300 Software .....	B-1
Uninstalling Software .....	B-2
Installing Software .....	B-2
Entering the General License Password .....	B-6
<b>Appendix C: Analyzer Tests .....</b>	<b>C-1</b>
Compliance at the Transport Stream Level .....	C-1
Compliance at the PES Packet Level .....	C-6
Compliance at the PSI level .....	C-8
Compliance for the Descriptors .....	C-12

## Glossary

## Index

## List of Tables

<b>Table i: Tektronix MPEG Test System version 6.0 applications . . .</b>	<b>x</b>
<b>Table ii: MTS300 MPEG Test System (V6.0) supported applications . . . . .</b>	<b>xii</b>
<b>Table 2-1: Icons used in the hierarchic view . . . . .</b>	<b>2-13</b>
<b>Table 2-2: PTS/DTS graphic view icons . . . . .</b>	<b>2-35</b>
<b>Table 3-1: File menu commands . . . . .</b>	<b>3-4</b>
<b>Table 3-2: Edit menu commands . . . . .</b>	<b>3-4</b>
<b>Table 3-3: Selection menu commands . . . . .</b>	<b>3-5</b>
<b>Table 3-4: Filters submenu commands . . . . .</b>	<b>3-6</b>
<b>Table 3-5: Analysis menu commands . . . . .</b>	<b>3-7</b>
<b>Table 3-6: Multiplex Characteristics submenu commands . . . . .</b>	<b>3-8</b>
<b>Table 3-7: Dynamic submenu commands . . . . .</b>	<b>3-8</b>
<b>Table 3-8: EMM submenu commands . . . . .</b>	<b>3-8</b>
<b>Table 3-9: PC2 dialog menu commands . . . . .</b>	<b>3-9</b>
<b>Table 3-10: Options menu commands . . . . .</b>	<b>3-10</b>
<b>Table 3-11: ATSC PSIP submenu commands . . . . .</b>	<b>3-10</b>
<b>Table 3-12: Add view menu commands . . . . .</b>	<b>3-11</b>
<b>Table 3-13: Help menu commands . . . . .</b>	<b>3-12</b>
<b>Table 3-14: Upper toolbar commands . . . . .</b>	<b>3-12</b>
<b>Table 3-15: Lower toolbar commands . . . . .</b>	<b>3-13</b>
<b>Table 3-16: File type definitions . . . . .</b>	<b>3-15</b>
<b>Table 3-17: Icons used in the PSI hierarchic view . . . . .</b>	<b>3-17</b>
<b>Table 3-18: Special hierarchic view symbols . . . . .</b>	<b>3-19</b>
<b>Table 3-19: Icons used in the SI hierarchic view . . . . .</b>	<b>3-19</b>
<b>Table 3-20: Icons used in the PSIP hierarchic view . . . . .</b>	<b>3-21</b>
<b>Table 3-21: SI consistency error abbreviations . . . . .</b>	<b>3-35</b>
<b>Table 3-22: SI consistency error abbreviations . . . . .</b>	<b>3-35</b>
<b>Table 3-23: Information in the PSI/SI/PSIP rate table . . . . .</b>	<b>3-37</b>
<b>Table 3-24: PTS/DTS graphic view icons . . . . .</b>	<b>3-42</b>
<b>Table 3-25: Analyzer default settings . . . . .</b>	<b>3-71</b>
<b>Table 3-26: MTS300 analysis and element icons . . . . .</b>	<b>3-73</b>
<b>Table 3-27: Message window keyboard commands . . . . .</b>	<b>3-74</b>
<b>Table 3-28: Message window popup menus . . . . .</b>	<b>3-74</b>
<b>Table 3-29: Expected input file types . . . . .</b>	<b>3-95</b>

<b>Table 3-30: DVB Channel Coding and Decoding menu commands</b>	<b>3-97</b>
<b>Table 3-31: Functions of the TMCC Expert Client toolbar buttons</b>	<b>3-113</b>
<b>Table 3-32: Color for each TMCC Expert Client modulation mode</b>	<b>3-114</b>
<b>Table 3-33: TMCC data syntax</b>	<b>3-115</b>
<b>Table 3-34: Syntax view LED icons and error conditions</b>	<b>3-116</b>
<b>Table 3-35: Functions of the TMCC Configuration Client</b>	
<b>Toolbar buttons</b>	<b>3-126</b>
<b>Table C-1: Compliance for the Transport Packet Header</b>	<b>C-1</b>
<b>Table C-2: Compliance for the Adaptation Field (AF)</b>	<b>C-3</b>
<b>Table C-3: Compliance for the PES packet header</b>	<b>C-6</b>
<b>Table C-4: Compliance for the PAT sections</b>	<b>C-8</b>
<b>Table C-5: Compliance for the PMT sections</b>	<b>C-9</b>
<b>Table C-6: Compliance for the CAT section</b>	<b>C-10</b>
<b>Table C-7: Compliance for the NIT sections</b>	<b>C-11</b>
<b>Table C-8: Compliance for the private sections</b>	<b>C-11</b>
<b>Table C-9: Compliance for all descriptors</b>	<b>C-12</b>
<b>Table C-10: Video stream descriptor</b>	<b>C-12</b>
<b>Table C-11: Audio stream descriptor</b>	<b>C-13</b>
<b>Table C-12: Hierarchy descriptor</b>	<b>C-13</b>
<b>Table C-13: Registration descriptor</b>	<b>C-14</b>
<b>Table C-14: Data stream alignment descriptor</b>	<b>C-14</b>
<b>Table C-15: Target background grid descriptor</b>	<b>C-14</b>
<b>Table C-16: Video window descriptor</b>	<b>C-15</b>
<b>Table C-17: CA descriptor</b>	<b>C-15</b>
<b>Table C-18: ISO 639 language descriptor</b>	<b>C-15</b>
<b>Table C-19: System clock descriptor</b>	<b>C-16</b>
<b>Table C-20: Multiplex buffer utilization descriptor</b>	<b>C-16</b>
<b>Table C-21: Copyright descriptor</b>	<b>C-16</b>
<b>Table C-22: Maximum bitrate descriptor</b>	<b>C-17</b>
<b>Table C-23: Private data indicator descriptor</b>	<b>C-17</b>
<b>Table C-24: Smoothing buffer descriptor</b>	<b>C-17</b>
<b>Table C-25: STD descriptor</b>	<b>C-17</b>
<b>Table C-26: IBP descriptor</b>	<b>C-18</b>



# General Safety Summary

Review the following safety precautions to avoid injury and prevent damage to this product or any products connected to it.

*Only qualified personnel should perform service procedures.*

While using this product, you may need to access other parts of the system. Read the *General Safety Summary* in other system manuals for warnings and cautions related to operating the system.

## Injury Precautions

**Use Proper Power Cord.** To avoid fire hazard, use only the power cord specified for this product.

**Avoid Electric Overload.** To avoid electric shock or fire hazard, do not apply a voltage to a terminal that is outside the range specified for that terminal.

**Avoid Overvoltage.** To avoid electric shock or fire hazard, do not apply potential to any terminal, including the common terminal, that varies from ground by more than the maximum rating for that terminal.

**Avoid Electric Shock.** To avoid injury or loss of life, do not connect or disconnect probes or test leads while they are connected to a voltage source.

**Ground the Product.** This product is grounded through the grounding conductor of the power cord. To avoid electric shock, the grounding conductor must be connected to earth ground. Before making connections to the input or output terminals of the product, ensure that the product is properly grounded.

**Do Not Operate Without Covers.** To avoid electric shock or fire hazard, do not operate this product with covers or panels removed.

**Use Proper Fuse.** To avoid fire hazard, use only the fuse type and rating specified for this product.

**Do Not Operate in Wet/Damp Conditions.** To avoid electric shock, do not operate this product in wet or damp conditions.

**Do Not Operate in an Explosive Atmosphere.** To avoid injury or fire hazard, do not operate this product in an explosive atmosphere.

## Product Damage Precautions

**Use Proper Power Source.** Do not operate this product from a power source that applies more than the voltage specified.

**Provide Proper Ventilation.** To prevent product overheating, provide proper ventilation.

**Do Not Operate With Suspected Failures.** If you suspect there is damage to this product, have it inspected by qualified service personnel.

**Symbols and Terms**

**Terms in this Manual.** These terms may appear in this manual:



---

**WARNING.** *Warning statements identify conditions or practices that could result in injury or loss of life.*

---



---

**CAUTION.** *Caution statements identify conditions or practices that could result in damage to this product or other property.*

---

**Terms on the Product.** These terms may appear on the product:

DANGER indicates an injury hazard immediately accessible as you read the marking.

WARNING indicates an injury hazard not immediately accessible as you read the marking.

CAUTION indicates a hazard to property including the product.

**Symbols on the Product.** The following symbols may appear on the product:



DANGER  
High Voltage



Protective Ground  
(Earth) Terminal



ATTENTION  
Refer to Manual



Double  
Insulated

**Certifications and  
Compliances**

Refer to the specifications section for a listing of certifications and compliances that apply to this product.

# Preface

This manual documents the MPEG-2 DVB/ATSC/ISDB-S/ARIB System Analyzer, Option CA (conditional access), and DVB Channel Coding and Decoding software applications.

If you purchased an MTS300 test system and are looking for information about hardware or software installation, first-time operation, or specifications, refer to the *MTS300 MPEG Test System Hardware and Software Installation Technical Reference*, Tektronix part number 071-0261-XX.

For the latest information about MTS300 software features and known problems, refer to the *MPEG Test System Software Version 6.0 Read This First* document, Tektronix part number 071-0666-XX, that accompanied your test system, software product, or upgrade.

## Manual Structure

This manual is divided into the following sections:

**Getting Started.** The Getting Started section contains all the information you need to get the MPEG-2 DVB/ATSC/ISDB-S/ARIB System Analyzer up and running.

**Operating Basics.** The Operating Basics section contains a tutorial that new users should use to familiarize themselves with the system analyzer. Experienced users can also consult the tutorial for detailed instructions for unfamiliar tasks.

**Reference.** The Reference section contains in-depth descriptions of the analyzer capabilities, the software interface, and configuration options. This section also contains information on how to use the conditional access and DVB channel coding and decoding software.

**Appendix A: What to Do if an Application Locks Up.** Appendix A describes how to recover if the test system locks up.

**Appendix B: Software Repair.** Appendix B contains information you might need to reinstall application files.

**Appendix C: Analyzer Tests.** Appendix C contains bitstream tests for some versions of MTS300 software.

**Glossary.** Consult the glossary when you encounter an unfamiliar term.

**Index.** The Index is an alphabetical listing of the topics covered in this manual.

## Symbols and Terms

Wherever possible, this manual uses symbols and terminology consistent with Microsoft® Windows™ and MPEG-2 standards. Refer to the Windows documentation (included with the test system) for definitions and explanations of Windows terminology. Refer to the *Glossary* at the rear of this manual for definitions unique to MPEG or the MTS300 test system.



*For information about the MPEG-2 standard, click the MPEG-2 help icon in the Tektronix MPEG Test System program group window.*

---

## Related Documents



For additional information about using MTS300 software to monitor, analyze, and generate MPEG-2, DVB, and ATSC data streams, refer to the following manuals:

- The *MTS300 MPEG Test System Real-Time Analysis User Manual*, Tektronix part number 071-0658-XX, contains information about using the real-time MPEG-2 System Analyzer application.
- The *MTS300 MPEG Test System Stream Creation Applications User Manual*, Tektronix part number 071-0778-XX, contains information about using the MPEG-2 DVB/ATSC Transport Stream Multiplexer, DVB Table Editor, ATSC Table Editor, DVB Channel Coding and Decoding, Jitter Adder, Error Injector, and OpenMux (real-time multiplexer) applications.
- The *MTS300 MPEG Test System Program Stream Analyzer User Manual*, Tektronix part number 071-0662-XX, contains information about using the deferred-time Program Stream Analyzer application.
- The *MTS300 MPEG Test System Dolby Digital Audio Stream Analyzer User Manual*, Tektronix part number 071-0661-XX, contains information about using the deferred-time AC-3 Audio Stream Analyzer application.
- The *MTS300 MPEG Test System Audio Stream Analyzer User Manual*, Tektronix part number 071-0663-XX, contains information about using the deferred-time MPEG Audio Stream Analyzer application.
- The *MTS300 MPEG Test System Video Stream Analyzer User Manual*, Tektronix part number 071-0664-XX, contains information about using the deferred-time MPEG Video Stream Analyzer application.











## Related Applications

The applications that appear in version 6.0 Tektronix MPEG Test System program group and Start menu depend on the system configuration and its installed options. Table i summarizes all test system applications available in release 6.0.





**Table i: Tektronix MPEG Test System version 6.0 applications**

Icon	Application title	Function	User document
 Master Client	Master Client	<p>Continuously monitor an input bitstream for compliance with the MPEG-2, DVB-SI, ATSC PSIP, and ISDB/ARIB digital television standards. Use this client to start or assign to an input/output the following real-time applications and servers:</p> <p><b>AnalysisServers</b>, MPEG and TMCC used to perform real-time analysis on a transport stream input</p> <p><b>Expert Client</b>, used display the results of real-time transport stream analysis performed by an MPEG analysis server.</p> <p><b>Configuration Client</b>, used to configure MPEG analysis servers for specific errors.</p> <p><b>TMCC Expert Client</b>, used to display the results of real-time transport stream analysis performed by a TMCC analysis server.</p> <p><b>TMCC Configuration Client</b>, used to configure TMCC analysis servers for specific errors.</p> <p><b>Stream Player</b>, used to generate transport streams from a local file.</p> <p><b>Stream Recorder</b>, used to capture transport stream input.</p> <p><b>OpenMux</b>, used to configure and generate transport streams from local transport stream and elementary stream files.</p>	MTS300 MPEG Test System Real-Time Analysis User Manual 071-0658-XX
 Hardware Diagnostic	Hardware Diagnostic	Perform onboard self-tests for the MPEG Test System.	MTS300 MPEG Test System Hardware and Software Installation Technical Reference 071-0667-XX  (Information repeated in both manuals)
 Private Syntax Interpreter	Private Syntax Interpreter	Create table definitions used by the Real-Time Analyzer to interpret private syntax sections.	

**Table i: Tektronix MPEG Test System version 6.0 applications (Cont.)**

Icon	Application title	Function	User document
 Deferred-Time Analyzer	MPEG-2 DVB/ATSC System Analyzer	Analyze transport streams and packetized elementary streams saved to the system disks.	MTS300 MPEG Test System MPEG-2 DVB/ATSC System Analyzer User Manual 071-0659-XX
 DVB Channel	DVB Channel Coding and Decoding	Code and decode transport stream files to DVB specifications.	MTS300 MPEG Test System Stream Creation Applications User Manual 071-0778-XX  (Information repeated in both manuals)
 Program Stream Analyzer	Program Stream Analyzer	Analyze MPEG program stream files.	MTS300 MPEG Test System Program Stream Analyzer User Manual 071-0662-XX
 Video Stream Analyzer	MPEG Video Stream Analyzer	Analyze MPEG-1 and MPEG-2 video elementary streams files or streams extracted from the MPEG-2 DVB/ATSC/ISDB-S/ARIB System Analyzer or Program Stream Analyzer.	MTS300 MPEG Test System Video Stream Analyzer User Manual 071-0664-XX
 Audio Stream Analyzer	MPEG Audio Stream Analyzer	Analyze MPEG-1 and MPEG-2 audio elementary streams files or streams extracted from the MPEG-2 DVB/ATSC/ISDB-S/ARIB System Analyzer or Program Stream Analyzer.	MTS300 MPEG Test System Audio Stream Analyzer User Manual 071-0663-XX
 Dolby Digital Analyzer	Dolby Digital Audio Stream Analyzer	Analyze Dolby Digital (AC-3) audio elementary stream files or streams extracted from the MPEG-2 DVB/ATSC/ISDB-S/ARIB System Analyzer.	MTS300 MPEG Test System Dolby Digital Audio Stream Analyzer User Manual 071-0661-XX
 Multiplexer	MPEG-2 Transport Stream Multiplexer	Create transport stream files from PSI/SI/PSIP table files, elementary stream files, and data files.	MTS300 MPEG Test System Stream Creation Applications User Manual 071-0778-XX
 TMCC Combiner	TMCC Combiner	The TMCC Combiner (MTS300 Option TM or MTS3FTM) is a wizard that guides you through creating a single- and multiple-stream transport stream files for ISDB-S environments.	
 DVB Table Editor	DVB Table Editor	Create and edit PSI and DVB SI table files for use with the transport stream multiplexer.	
 ATSC Table Editor	ATSC Table Editor	Create and edit PSI and ATSC PSIP table files for use with the transport stream multiplexer.	
 ARIB Table Editor	ARIB Table Editor	Create and edit ARIB table files for use with the transport stream multiplexer.	

**Table i: Tektronix MPEG Test System version 6.0 applications (Cont.)**

Icon	Application title	Function	User document
 Jitter Adder	Jitter Adder	Add jitter to PCR data in MPEG-2 transport stream files.	MTS300 MPEG Test System Stream Creation Applications User Manual 071-0778-XX
 Error Injector	Error Injector	Insert or correct errors in transport stream packets.	
 License Manager	Tektronix Software Protection	Enter or reenter the general password to enable licensed applications.	Read This First, MTS300 MPEG Test System Software V6.0 071-0666-XX
 MPEG-2 Help	MPEG2_Part1 (ISO/IEC 13818-1)	The international MPEG-2 system standard in Windows Help format.	none
 Uninstall MTS	Uninstall MTS	Remove MPEG Test System software from the system disk.	MTS300 MPEG Test System User Manuals

## Software Version

Table ii lists the MTS300 MPEG Test System application version numbers supported by this manual. To verify an application version number, select **Help** in the application menu bar; then select **About** from the Help menu.

**Table ii: MTS300 MPEG Test System (V6.0) supported applications**

MPEG-2 DVB/ATSC System Analyzer	V5.02 and above
DVB Channel Coding and Decoding	V1.0 and above



## Contacting Tektronix

<b>Phone</b>	1-800-833-9200*
<b>Address</b>	Tektronix, Inc. Department or name (if known) 14200 SW Karl Braun Drive P.O. Box 500 Beaverton, OR 97077 USA
<b>Web site</b>	<a href="http://www.tektronix.com">www.tektronix.com</a>
<b>Sales support</b>	1-800-833-9200, select option 1*
<b>Service support</b>	1-800-833-9200, select option 2*
<b>Technical support</b>	Email: <a href="mailto:techsupport@tektronix.com">techsupport@tektronix.com</a> 1-800-833-9200, select option 3* 1-503-627-2400 6:00 a.m. - 5:00 p.m. Pacific time

---

\* **This phone number is toll free in North America. After office hours, please leave a voice mail message. Outside North America, contact a Tektronix sales office or distributor; see the Tektronix web site for a list of offices.**





# Getting Started



# Getting Started

With the MPEG-2 DVB/ATSC/ISDB-S/ARIB System Analyzer you can test transport streams for compliance with MPEG-2, DVB, and ATSC television standards.

The information in this section explains how to install software and run the analyzer for the first time.

## Requirements

You can install the MPEG-2 DVB/ATSC/ISDB-S/ARIB System Analyzer on either a Tektronix MTS300 MPEG Test System or a personal computer with the following minimum requirements:

- 150 MHz Intel Pentium processor
- 32 MB RAM
- 140 Mbytes free disk space (for MTS software) plus adequate space for transport stream test files
- CD ROM drive (for software installation)
- Windows NT 4.0 operating system (Service Pack 6)
- 1024 x 768 pixel video monitor with 256 available colors

If you are installing the analyzer software on an Tektronix MTS300 MPEG Test System, refer to the *MTS300 MPEG Test System Hardware and Software Installation Technical Reference* (included with the test system) for complete installation instructions.

### Software Key

You must install the software key (included with the software) on the computer parallel port before you can start the system analyzer.

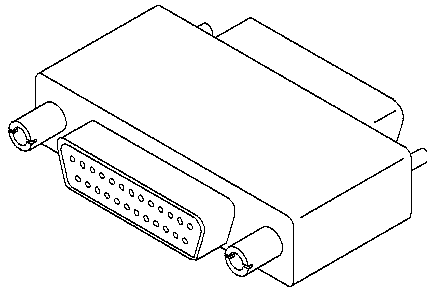

To use the parallel port with the software key installed, attach any ancillary cables directly to the software key. The software key will not interfere with parallel port communications.

---

**NOTE.** To run the MPEG-2 DVB/ATSC/ISDB-S/ARIB System Analyzer, the software key must be installed on the computer parallel port. Do not remove or misplace the software key.

---

## Logging On

To run the MPEG-2 DVB/ATSC/ISDB-S/ARIB System Analyzer software on your personal computer or MTS300 test system, use the appropriate logon procedure.

### **Tektronix MTS300 MPEG Test System**

To run the MPEG-2 DVB/ATSC/ISDB-S/ARIB System Analyzer on an Tektronix MTS300 MPEG Test System, use the following procedure to log on.

1. Switch the computer power on to begin Windows NT initialization. Initialization can take up to two minutes. Under normal circumstances, no action is required until the Begin Logon window appears.
2. When the Begin Logon window appears, simultaneously press the **CTRL + ALT + Delete** keys to open the Logon Information dialog box.

You should not need to log on to Windows NT if you are using the default auto-logon feature (with Administrator and MPEG2 as the user name and password). However, if this behavior has been changed, complete the log on procedure by performing step 3.

3. Enter your user name and password in the User name and Password text boxes, and press **ENTER**.

**Personal Computer**

You can run the MPEG-2 DVB/ATSC/ISDB-S/ARIB System Analyzer on a personal computer that has no MTS300 system hardware.

1. Switch the computer power on to begin Windows NT initialization. Initialization can take up to two minutes. Under normal circumstances, no action is required until the Begin Logon window appears.
2. When the Begin Logon window appears, simultaneously press the **CTRL + ALT + Delete** keys to open the Logon Information dialog box.
3. Enter your user name, password, and domain. Press **ENTER**. These parameters must be previously set up by your NT administrator.

**Changing Passwords**

You can change passwords at this time. Refer to the Windows NT online help for instructions. If you change passwords, be sure to create a new emergency repair disk as explained in *Appendix B: Software Repair*.

**Installing Software**

---

**NOTE.** *If you do not have the Java run-time environment installed on your system, or if the environment is incorrect for this software, run the executable file located in the jre directory on the Application CD.*

---

Perform the following steps to install the System Analyzer software on your personal computer.

1. Install the software key as described in *Software Key* on page 1-1.
2. Log on to Windows NT as Administrator.
3. Right-click the **My Computer** icon on your desktop, and then select **Explore** from the resulting submenu. In the Exploring window, select the icon that represents the disk drive onto which you will install the software (usually drive C:).

4. Check the status bar at the bottom of the Exploring window to verify that the target disk has at least 140 Mbytes of free space. You cannot install the software on a disk with less than 140 Mbytes of free space.

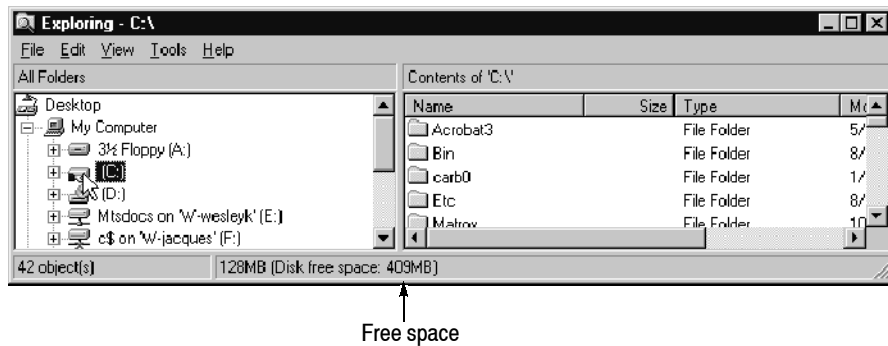

5. Place the *MPEG Test System Version 6.0 Installation Software* CD ROM into the CD ROM drive.
6. Click the Windows NT **Start** button and select **Run...** from the submenu.
7. Enter `d:\Setup.exe` in the resulting Run window as depicted in the following illustration. In this example, *d* is the drive letter for the CD ROM drive; use the drive letter that is correct for your computer.



8. Click **OK** to start the software installation.
9. In a few seconds, the installation screen appears.
10. Read the Copyright and Setup text and click **Next** to proceed to the Choose Destination Directory window.
11. The default destination folder is `C:\MTS300`. Click **Next** to accept the default folder.

---

**NOTE.** *It is strongly recommended that you use the default destination folder.*

---



12. The Setup Type window opens. Select **MTS Software Only**, and then click **Next**.

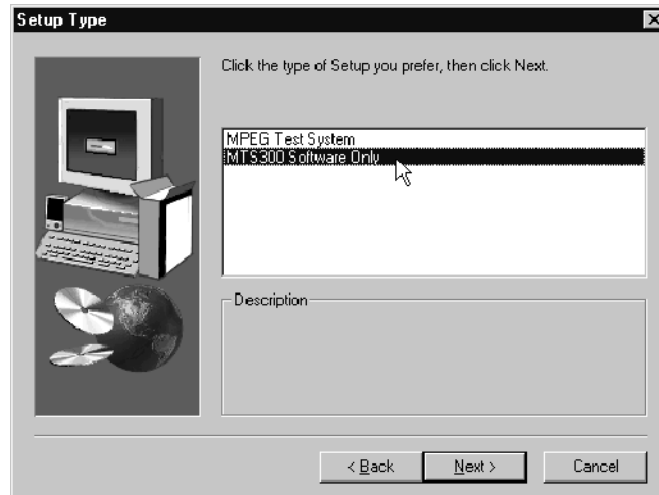

13. The Select Program Folder window opens. Click **Next** to accept the default folder name (Tektronix MPEG Test System) and continue.
14. Review the Destination Directory, System Product, and Start Menu Folder selections in the Selection Summary window. If the selections are incorrect, click **Back** and change the information as needed. Once the information is correct, click **Next** to proceed with the installation.

The setup program begins installing the software and related files. The activity and progress gauges appear at first to show that the installation is progressing. Installation proceeds without your input (and sometimes with no apparent activity) for approximately 3 minutes, depending on your computer.

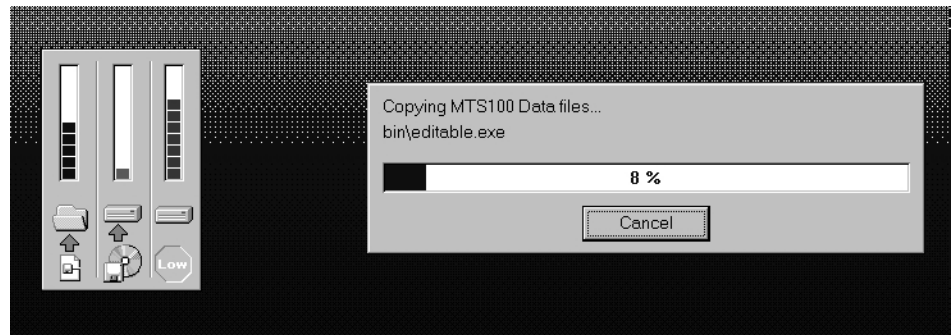

15. During a normal setup, the computer displays two empty program group windows after it copies the program files to your disk drive. After the windows appear, a message reminds you to verify that the software key is installed.
16. Verify that the software key is installed on the parallel (printer) port as described in *Software Key* on page 1-1; then click **OK**.
17. The Setup Complete window opens; click **Finish** to continue.
18. A Notepad window opens to display the Readme file. Scan the text for important information, and then select **Exit** from the File menu to close the window.
19. Another Setup Complete window opens. Accept *Yes, I want to restart my computer now*.
20. Remove the test system software installation disk from the CD ROM drive and click **Finish** to complete the setup and reboot the system.
21. When prompted, log on as any user. The Windows NT initialization process can take up to two minutes to complete.

## Entering the License Password

Perform the remaining steps to enter the general password that corresponds to the attached software key. Doing so enables the applications that are included with your MTS300 MPEG Test System product.



1. Double-click the **License Manager** icon to start the application. The Tektronix Software Protection window appears.



2. Consult the password document supplied with your software and identify the general password.
3. Enter the three 6-character hexadecimal numbers of the password in the corresponding Tektronix Software Protection window entry fields (lowercase characters are acceptable).
4. Click **OK**. A License message window appears.
5. If the password is correct, click **OK** to acknowledge the message. If you made an error entering the password, click **OK** and return to step 3.

Restart the computer (again) to complete the MPEG-2 DVB/ATSC/ISDB-S/ARIB System Analyzer software installation.

## Running the Software

Locate the Tektronix MPEG Test System icon on the Windows NT desktop. If it is not already open, double-click the folder icon to open the program group window.

The Tektronix MPEG Test System program group window appears as shown below. Double-click on the **Deferred-Time Analyzer** icon to start the analyzer.

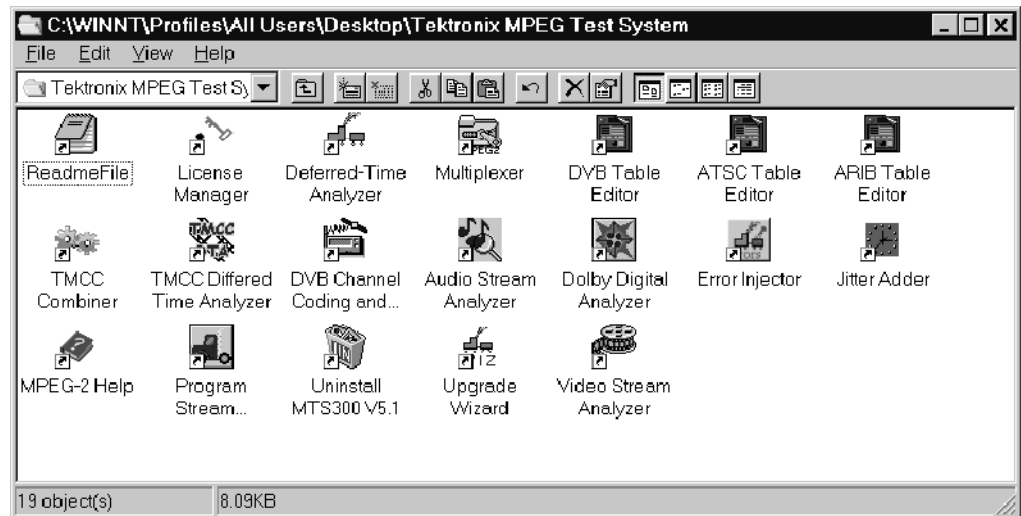

### Exiting MTS300 Applications

To exit an MTS300 application, select **Exit** from the application File menu or click the close box in the upper-right corner of the application window. The current configuration is preserved and used the next time you start the application.



In the default configuration, application information and error messages (up to 2048 KB) are automatically saved in the Windows NT Event Viewer. No additional information is saved.

## Shutting Down the Computer

To avoid loss of data and possible problems during subsequent Windows NT initialization, always shut down Windows NT before switching the computer power off. To shut down Windows NT, select **Shut Down** from the Start menu.



In the Shut Down Windows dialog box, select **Shut down the computer?** and then click **Yes**. After a few seconds, the Shutdown Computer window appears with the message *It is now safe to turn off your computer*. You can now power off the computer.



---

**CAUTION.** Do not switch computer power off before the message *It is now safe to turn off your computer* appears. Doing so may result in lost data and difficulty in restarting Windows NT.

---

## Software Repair

If you experience operating problems following the installation of application software or if the system becomes corrupt, refer to *Reinstalling the MTS300 Software* in Appendix B.





# Operating Basics





# Operating Basics

This section describes the features and identifies the components of the MPEG-2 DVB/ATSC/ISDB-S/ARIB System Analyzer. This section also contains a tutorial to introduce you to the operation and capabilities of the analyzer. The files required for this exercise are included with the application. When you complete the tutorial, you are encouraged to analyze your own input streams and experiment with the configurations and options.

If you need additional information on any topic while reading this section, refer to the *Reference* section beginning on page 3-1.

## Deferred-Time Analysis

The MPEG-2 DVB/ATSC/ISDB-S/ARIB System Analyzer uses several graphical views to present transport stream data. These views give access to each field, and each bit if you wish, within the transport packets, PES packets, and the various PSI, SI, and PSIP tables.

**Hierarchic View.** The Hierarchic View is a diagram of the data components carried by the transport stream. This view graphically depicts the MPEG transport stream file by using icons to show the interrelationship of its components. These icons identify each PAT (Program Association Table), NIT (Network Information Table), PMT (Program Map Table), and PES (Packetized Elementary Stream) packet, and three types of elementary stream (video, audio, and data). Additional icons indicate the PID (Packet Identification) number for each data component.

For additional information on this view, refer to *The Hierarchic View*, beginning on page 3-15.

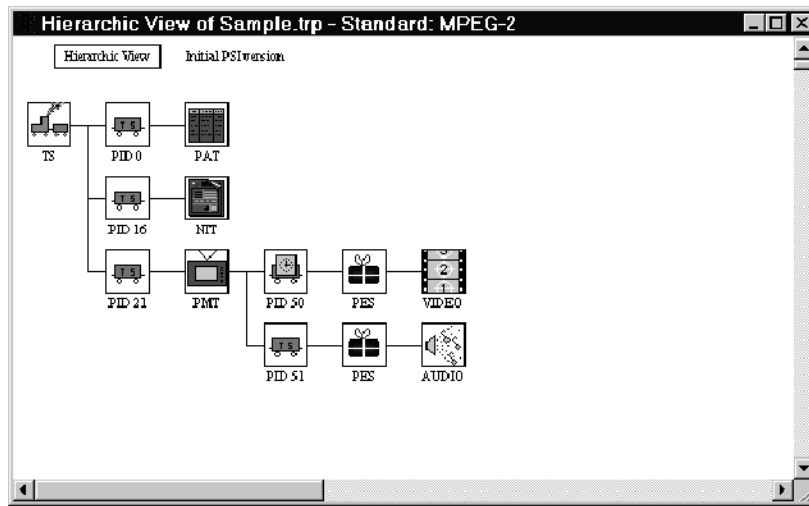

**Interpreted View.** The interpreted view shows every field in the selected transport packet, table section, or PES (packetized elementary stream) packet. Any packet in the file can be accessed. You can search for errors in this view.

The interpreted view shown below is of one 188-byte transport packet in the SAMPLE.TRP binary stream; this view can be created by double-clicking on the TS (engine and tender) icon in the Hierarchic view.

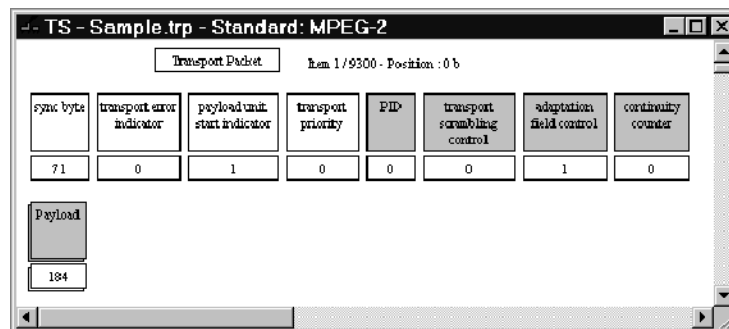

For additional information on this view, refer to *The Interpreted View*, beginning on page 3-23.

**Timing Displays.** Two types of timing displays are available: PCR (Program Clock Reference) contained in the transport packet headers and PTS/DTS (Presentation/Display Time Stamp) contained in PES packet headers. The PCRs are shown in a graphical format indicating their arrival time. The graphical display of the PTS/DTS shows a time line for each access unit (such as a video frame) indicating data arrival and value of each time stamp.

## Acquiring Transport Stream and Elementary Stream Files

The standard configuration Tektronix MTS300 MPEG Test System includes sample video and audio elementary stream files and a sample transport stream file in the *Cfg-trp* directory. These files contain pictures, common industry test signals, and sample signals in MPEG-2 format. Use these files as example formats for the tutorials and to construct sample transport streams.

Two additional sources of elementary stream files are available: a CD ROM (Tektronix part number 063-1914-XX) and the Tektronix FTP site.

### Test System CD ROM

To use the files on the CD ROM, either copy the files to the C:\MTS300 directory on the system disk or leave the disk in the CD ROM drive.

**Audio Files.** The CD ROM contains the following audio files in the Audio directory:

15kz-064.mp2	4kz-064.mp2
15kz-128.mp2	4kz-128.mp2
15kz-192.mp2	4kz-192.mp2
15kz-256.mp2	4kz-256.mp2
1kz-064.mp2	Music064.mp2
1kz-128.mp2	Music128.mp2
1kz-192.mp2	Music192.mp2
1kz-256.mp2	Music256.mp2
400-064.mp2	Sync-064.mp2
400-128.mp2	Sync-128.mp2
400-192.mp2	Sync-192.mp2
400-256.mp2	Sync-256.mp2

The file names indicate the elementary stream bit rate. For example, the file *15kz-256.mp2* contains a 15 kHz audio tone at 0.256 Mbits/s.

The following Dolby digital audio files are also available:

```
acmod2_0.ac3
acmod3_0.ac3
acmod3_2.ac3
```

**Video Files.** The CD ROM has a Video directory containing a 525 and a 625 directory. The *Video\525* directory contains streams with 525-line video; the *Video\625* directory contains streams with 625-line video. The directories contain the following listed files:

100b_015.mp2	Mulb_120.mp2
100b_060.mp2	Pulb_015.mp2
100b_120.mp2	Pulb_060.mp2
Bbc3_015.mp2	Pulb_120.mp2
Bbc3_060.mp2	Sync_015.mp2
Bbc3_120.mp2	Sync_060.mp2
Cact_015.mp2	Sync_120.mp2
Cact_060.mp2	Tens_015.mp2
Cact_120.mp2	Tens_060.mp2
Mobl_015.mp2	Tens_120.mp2
Mobl_060.mp2	V700_015.mp2
Mobl_120.mp2	V700_060.mp2
Mulb_015.mp2	V700_120.mp2
Mulb_060.mp2	

The file names indicate the elementary stream bit rate. The file *100b\_060.mp2*, for example, contains a video elementary stream with a bit rate of 6.0 Mbits/s.

**Examples Directory.** The CD ROM also contains the following files in the Examples directory:

10khz.mp2	Demo_060.mp2
1khz.mp2	Sample.trp
Demo_015.mp2	

### **MPEG Test System FTP Site**

You can access the same signals (and any new bit streams that become available) via anonymous FTP from the Tektronix FTP site, *ftp.tek.com*. If you have a web browser, point it to the following URL:

`FTP://ftp.tek.com/tv/test/streams/Element/`

Or, use FTP to contact `ftp.tek.com`. Log in as anonymous and use your email address as the the password. MPEG files are available in the subdirectories of */tv/test/streams/Element*. Each directory contains a *Readme.txt* file that describes its contents.

The following script illustrates the procedure for connecting to the MPEG Test System FTP site. Your entries are indicated with bold face type. Remember to transfer data in binary mode.

```
% ftp ftp.tek.com
```

Connected to inet1.tek.com.  
220 inet1 FTP server (Version wu-2.4(1) Sun Jan 29 12:29:00 GMT 1995)  
ready.

Name (ftp.tek.com:user): anonymous

331 Guest login ok, send your complete e-mail address as password.

Password: enter your email address

230-

230- T E K T R O N I X F T P A R C H I V E

230- /

230-

230 Guest login ok, access restrictions apply.

ftp> cd /tv/test/streams/Element

250 CWD command successful.

ftp> get README.TXT

The data included in this FTP site distribution is available to you on an as-is basis. Tektronix disclaims any and all warranties, whether express, implied, or statutory, including any implied warranties of merchantability or of fitness for a particular purpose.

If you do not have access to FTP, contact Tektronix at 1-800-TEK-WIDE and ask for MPEG Test System support. An engineer will help you acquire the data. If you have Internet access but are having trouble accessing the site, contact your local system administrator.



# Tutorial: Analyzing a Transport Stream

This tutorial introduces the features and capabilities of the MPEG-2 DVB/ATSC/ISDB-S/ARIB System Analyzer. Using step-by-step procedures and a standard sample transport stream file, you can follow along with your test system.

---

**NOTE.** This tutorial is written assuming a basic level of familiarity with the Windows 95 or Windows NT 4.0 operating system. If you are not comfortable with either operating system, review the Windows NT documentation.

---

## Getting Help

Additional information on MPEG-2 bit streams and analyzer operation is available from the following convenient sources:

- The *Reference* section of this manual, *MPEG-2 DVB/ATSC/ISDB-S/ARIB System Analyzer*, beginning on page 3-1.
- The analyzer Help menu.
- The MPEG-2 Help utility, which contains applicable MPEG-2 standards in Windows Help format.

Double-click on the **MPEG-2 Help** icon in the Tektronix MPEG Test System program group window to start the Help utility.

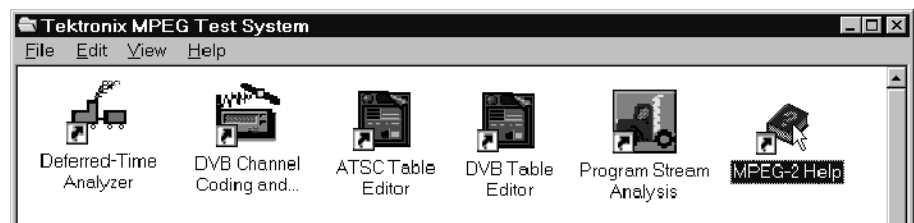

## Starting the Analyzer Application

Double-click on the **Deferred-Time Analyzer** icon in the Tektronix MPEG Test System program group window to start the application and open the application window.

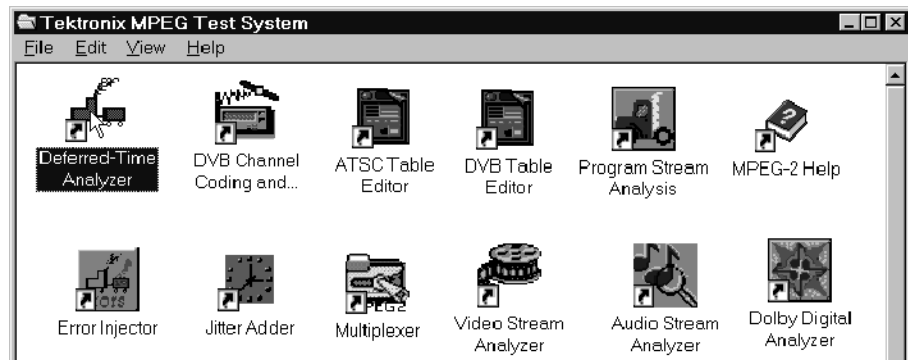

## The Application Window

The following illustration notes the important features of the analyzer application window.

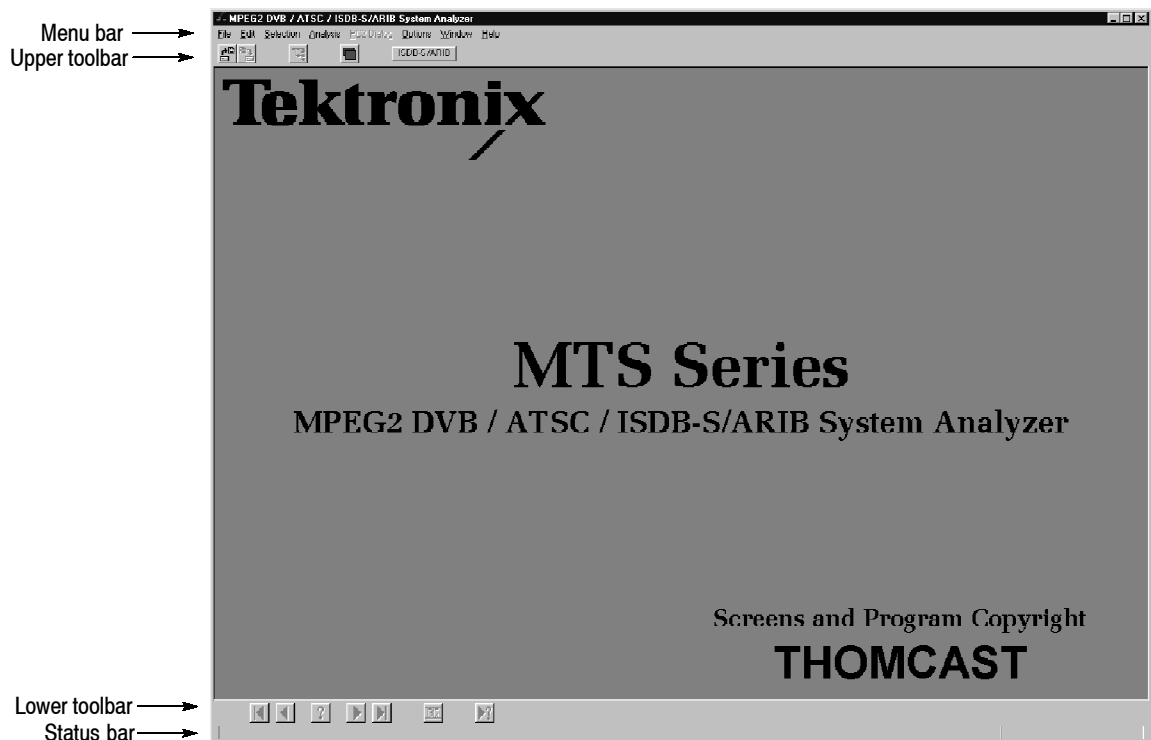



**Menu Bar** The Menu Bar contains the following menus:

- **File.** Use File menu commands to control the analyzer/disk interface and printing.
- **Edit.** Use Edit menu commands to move among items (transport packets, elementary stream packets, table sections) in the selected document window.
- **Selection.** Use Selection menu commands to control extractions from a transport stream file.
- **Analysis.** Use Analysis menu commands to access the stream analysis functions.
- **Unscrambling.** Use the Unscrambling menu command to access the Unscrambling parameters entry dialog box. Available only if Option CA (conditional access) is enabled.
- **PC2 Dialog.** Use PC2 Dialog menu commands to send entitlement messages to the PC2 card reader.
- **Options.** Use Options menu commands to select analyzer configuration options.
- **Window.** Use Window menu commands to manage the various open document windows.
- **Help.** Use the Help menu to access various forms of help information.

**Upper Toolbar** The upper toolbar contains command button shortcuts for several menu commands. Click on a button to execute a command.

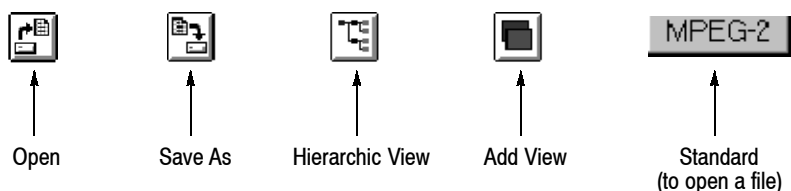

To display an tooltip of a command button function in the status bar (at the bottom of the application window), position the cursor over the command button.

**Lower Toolbar**

The lower toolbar contains command button shortcuts for the Edit menu commands. Click a button to execute a command. The buttons are available only when the active window contains an open file.

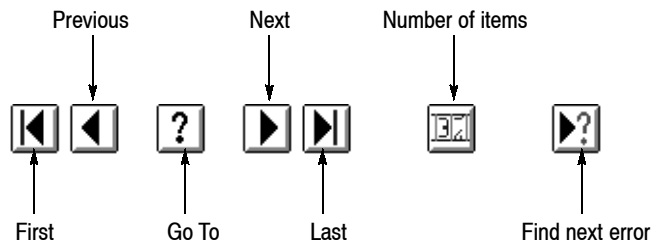

**Status Bar**

To display an explanation of a menu selection in the status bar, position the cursor over the menu selection.

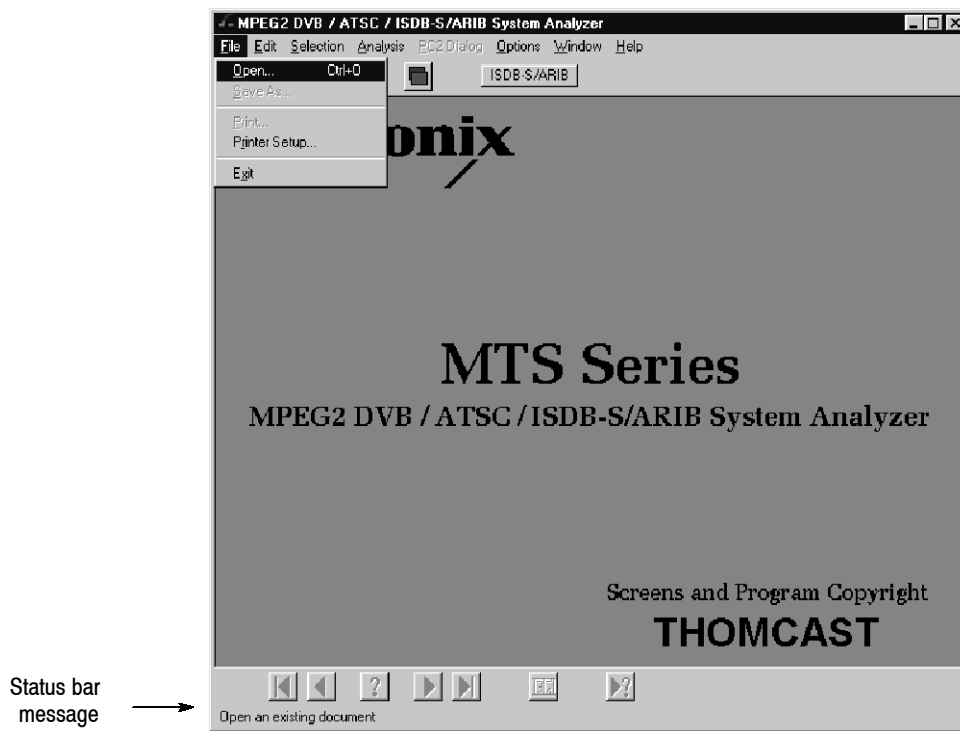

## Opening an Existing Transport Stream File

Open the sample transport stream file *Sample.trp*.

---

**NOTE.** You must specify the measurement standard (MPEG-2, DVB, ATSC or ISDB-S/ARIB) before opening a file.

---

1. Select **MPEG-2** from the Options menu.
2. Select **Open** from the File menu. A standard Windows Open dialog box appears within the application window.

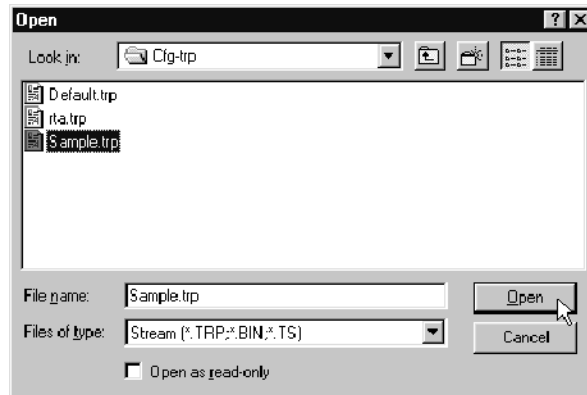

3. Select **Stream** from the Files of type list.
4. Select **Cfg-trp** from the Look in list.
5. Select **Sample.trp**.
6. Click **Open**.

The Hierarchic View of Sample.trp window appears within the application window.

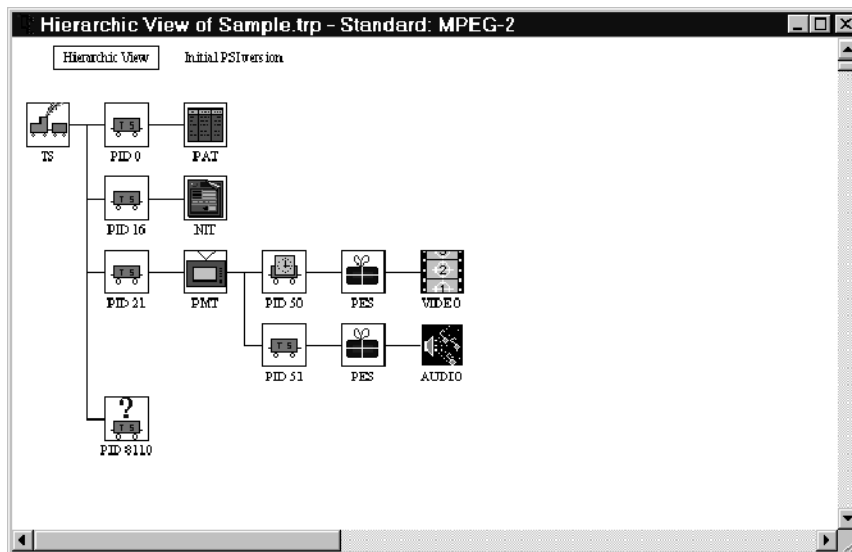

---

**NOTE.** The Analyzer cannot generate a hierarchic view if the stream does not contain a PAT (program association table, PID 0) or PMT (program map table).









The hierarchic view that appears when you first open a file is based on the first versions of the PAT and PMT tables found in the stream. You can use the Next command in the Edit menu or click on the Next command button (in the lower toolbar) to go to the next PSI version, if any, in the stream.

---











## The Hierarchic View

When you open a multiplex file in the application window, a hierarchic view appears. The hierarchic view uses icons to show the interrelationship of stream components and is the starting point for many types of analyses. With the hierarchic view, you can contextually select, display, and analyze specific portions of the transport stream. Table 2-1 describes the System Analyzer hierarchic view icons.

**Table 2-1: Icons used in the hierarchic view**

Icon	Element type
	Multiplex transport packets. This icon represents all (188/204/208-byte) transport packets that make up the stream. If you visualize the transport stream as a train, this icon represents every car in the train, regardless of its configuration or what it contains.
	Transport packets of a particular PID (Program ID). Other elements (tables, clocks, PES packets) are the “payload” contained within transport packets or are constructed from the payload of several transport packets that have the same PID. The PID number appears under the icon.  In the hierarchic view, the icon to the right of this icon represents the payload of packets with this PID.
	Transport Packets that contain independent PCR clocks. The PID appears under the icon.
	PAT (Program association table) sections. Always contained in PID 0 transport packets.
	CAT (Conditional access table). The CAT table allows you to associate one or more conditional access systems with the transport stream.
	PMT (Program map table) sections.
	NIT (Network information table). Provides access to service information tables through the PSI/SI/PSIP commands from the Selection menu. Also used for Private sections.  When the DVB option is selected in the Options menu, this icon can represent SDT, BAT, EIT, TDT, TOT, and TSDT sections, plus DIT and SIT sections. When the PSIP option is selected in the Options menu, this icon can represent MGT, EIT, ETT, T/CVCT, RRT, and STT sections. The table type is listed below the icon.  When the ISDB-S/ARIB option is selected in the Options Menu, this icon can represent EIT, SDT, DIT, SIT, TSDT, TDT, TOT, BIT, DCT, DLT and SDTT sections.
	PES (Packetized elementary stream). This icon represents all packets that, together, contain a given elementary stream. Individual PES packets are assembled from the payloads of several transport packets.

**Table 2-1: Icons used in the hierarchic view (Cont.)**

Icon	Element type
	MPEG video elementary stream.
	Digicipher II video elementary stream.
	MPEG audio elementary stream.
	Dolby digital (AC-3) audio elementary stream.
	AAC (Advanced Audio Coding) audio elementary stream.
	Data elementary stream.
	MIP (Mega-frame initialization packet). The MIP defines the start of the mega-frame and the transmission characteristics of the DVB-T (terrestrial DVB) transport stream.
	DSM CC (Digital storage media command and control).
	ECM (Entitlement control message) sections.
	EMM (Entitlement management message) sections.

**Shortcut Menus.** Each type of hierarchic view icon has a context-specific shortcut menu that allows quick access to the functions available specifically for the chosen element. Display this menu by clicking the right mouse button on the icon. Hold the mouse button down, highlight the desired command, and release the button to select the command.

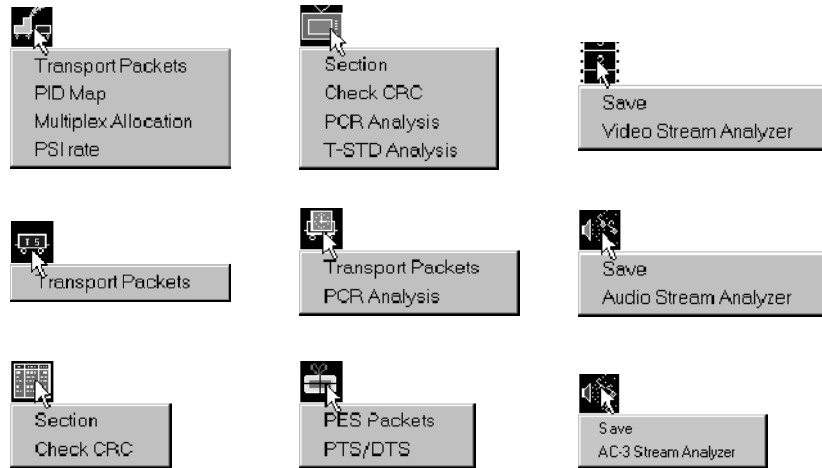

**NOTE.** You can select the first command on the shortcut menu (or the only command in one-item menus) by double-clicking on the icon. For all except elementary stream icons, this will open an Interpreted View of the packet or section.

## Exploring the TS Icon

1. Click on the **TS** icon with the right mouse button and hold the button down to open the TS shortcut menu.

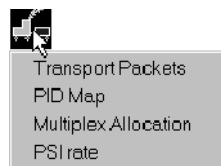

2. Highlight **Transport Packets** and release the button. This opens an interpreted view of the first complete transport packet in the stream.

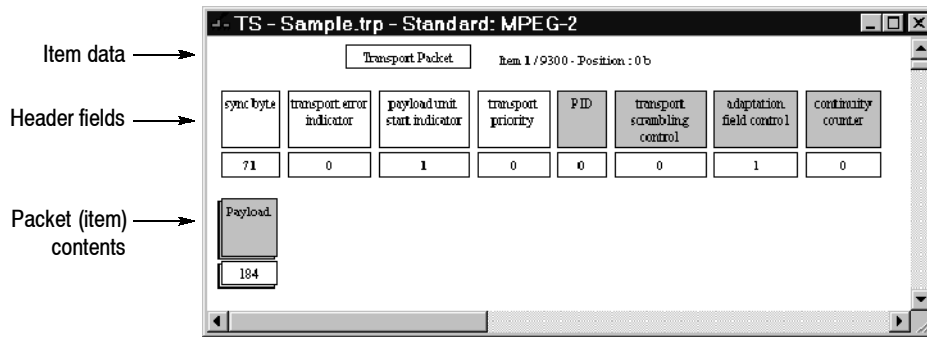

**NOTE.** You can also open the same interpreted view by double-clicking the TS icon.

### The Interpreted View

The interpreted view shows the structure of the transport packet and provides access to all the information contained in the packet header and payload. The transport packet display shows one transport packet at a time.

1. Use the command buttons on the lower toolbar to scroll through the transport packets; notice that the Item number changes as you scroll.

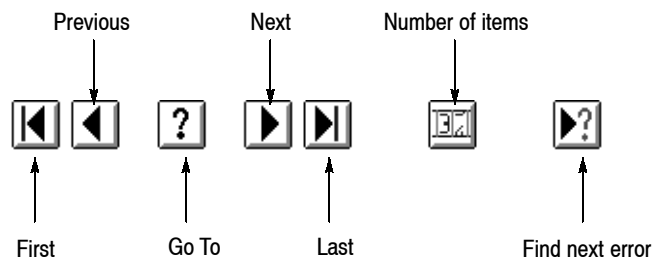

The transport stream in Sample.trp consists of 9300 transport packets, as indicated by the item number (Item 1/9300) at the top of the display. If an interpreted view does not show this information when the view is first opened, click on the Number of Items or the Last command button to add the information to the item data.



- Find the next packet syntax error in the stream by clicking the Next error button. The program will search forward in the stream until it either finds an error or reaches the end of the file. If it finds an error, it displays the interpreted view of the transport packet that contains the error. Because there are no syntax errors in any *Sample.trp* transport packets, the Analyzer displays the No Error Found message.



- You can learn about specific packet fields by double-clicking on the rectangle that identifies the field. Double-click the PID rectangle now.

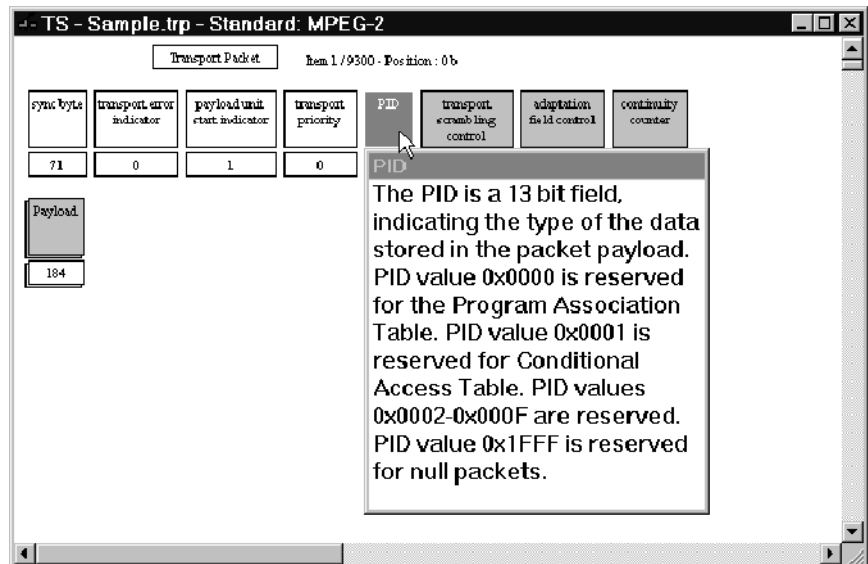

- Click anywhere in the interpreted view outside the field name message box to dismiss the message. Then double-click on PID value **0**, to display help information about this value. In this case, the message reminds you that PID 0 always identifies the PAT.

sync byte	transport error indicator	payload unit start indicator	transport priority	PID	transport scrambling control	adaptation field control	continuity counter
71	0	1	0	0	0	1	0

Payload

Program Association Table

- Sometimes you can learn more by looking at field values displayed in hexadecimal base. Use one of the following methods to display hexadecimal values:
  - Select **Base** from the Options menu; click the **Hexadecimal** option button in the Base dialog box; click **OK** to proceed.
  - Press the **F2** function key to toggle field values (and values in the hierarchic view) between decimal and hexadecimal base.

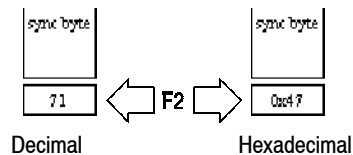

### The Hexadecimal View

The hexadecimal view shows all bytes that make up the current item. An MPEG-2 transport packet contains either 188, 204, or 208 bytes.

- To open a hexadecimal view, click the **Add View** command button on the upper toolbar. The View Type submenu opens.

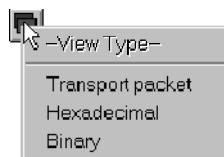

2. Select **Hexadecimal** from the submenu. This produces a hexadecimal view of the current transport packet.

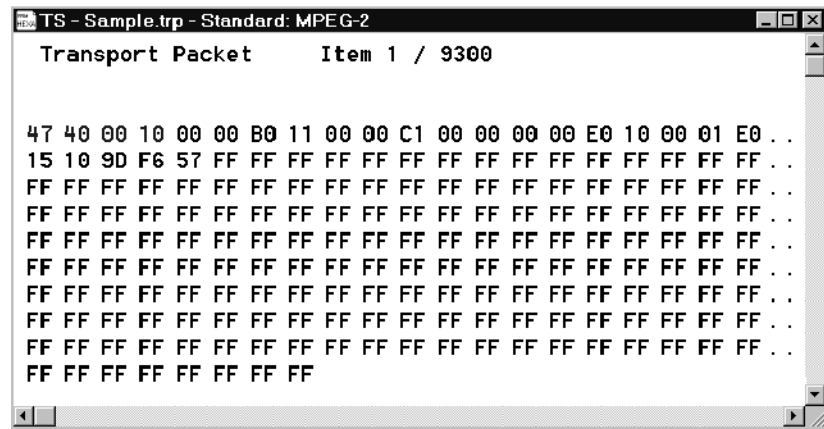

The first few bytes appear in blue characters on the display to indicate that they are required header information for the type of item. A transport packet has four required bytes. The blue, required bytes may be followed by several bytes shown in gray (for an example, use the command buttons to go to transport packet three of *Sample.trp*). The gray bytes are optional or variable header information. The remaining bytes, displayed with black characters, are the payload or data bytes. When viewing 204 byte length packets, the last 16 bytes are shown in Red.

3. Close both transport packet windows (interpreted and hexadecimal views). You are ready to look at a PID map of the sample transport stream.

### PID Map

The PID map can help you find the stream location and exact packet (item) number of a particular table section.

1. Click on the hierarchic view **TS** icon with the right mouse button. Hold the button down to open the shortcut menu.
2. Select **PID Map** from the menu.

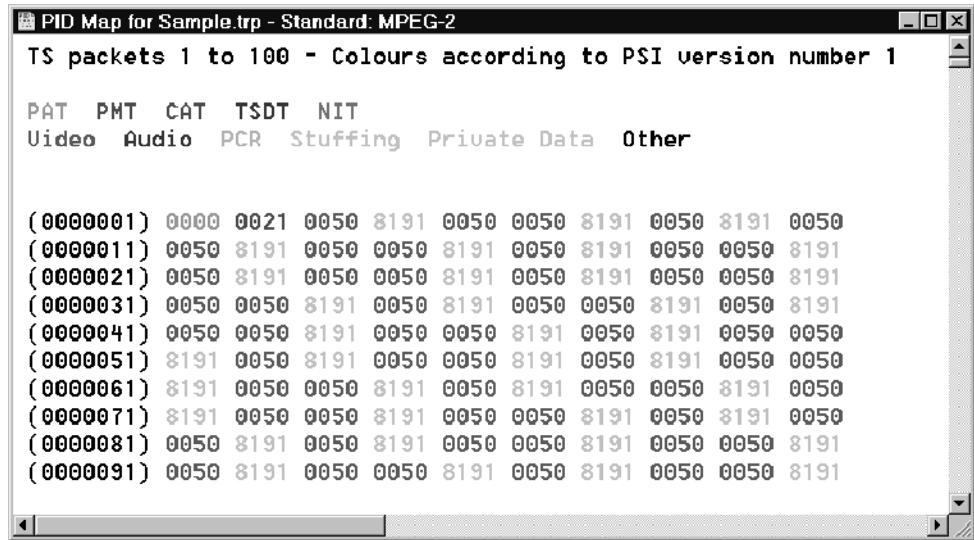

The PID map represents every transport packet in the stream with its PID (for uniformity, every PID is listed in a four-digit field). The black numbers down the left side of the window indicate the packet number of the first packet of every row. In the map, each unique PID is color-coded according to the type of element it identifies. For example, light green characters signify PIDs of packets that contain PAT sections. The first PAT section is in packet one.

3. Click the **Next** command button (▶) repeatedly until you see the next light green PID. The second PAT section in *Sample.trp* is in packet 334.
4. Close the PID map. You are ready to look at the Multiplex Allocation in a sample transport stream.

**Multiplex Allocation**

You can use the Multiplex Allocation view to see what portion of the transport stream multiplex is used by each PID.

1. Click on the hierarchic view **TS** icon with the right mouse button to open the shortcut menu. Select **Multiplex Allocation** to open the Multiplex Allocation for the *Sample.trp* window.

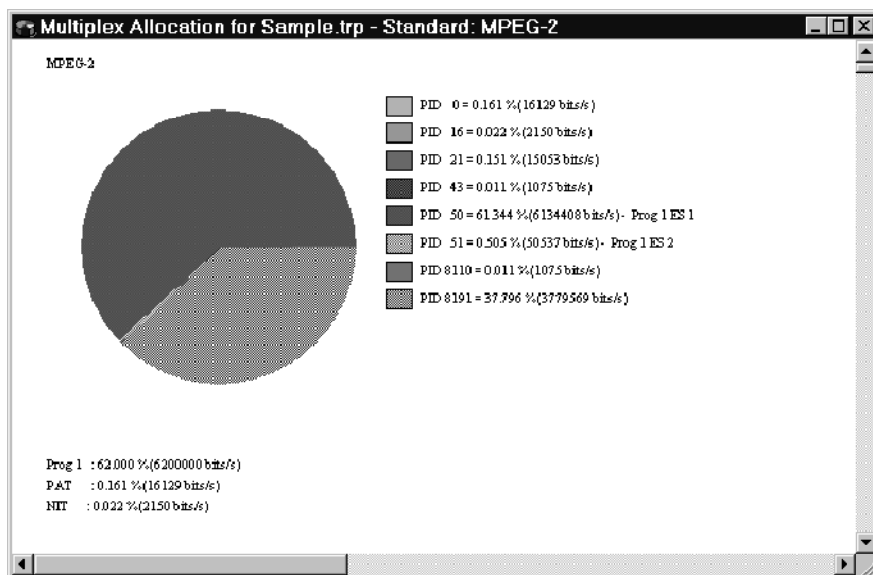

You may find the multiplex allocation pie chart useful for determining which PIDs are present in the transport stream and for confirming that each PID uses the expected amount of the multiplex.

---

**NOTE.** PID 8191 is the stuffing PID; it is not shown in the hierarchic view.

---

2. Close the multiplex allocation window. You are ready to look at the transport packets of a particular PID with a minimum of clutter.

## Exploring the Transport Packet Icon

The transport packet (rail car) icon represents transport stream packets that are identified with a particular PID. Other elements (such as table sections or PES packets) are the payload contained within these transport packets; the elements may be fully contained within one packet or constructed from the payload of several packets with the same PID. The PID number appears under the transport packet icon. In the hierarchic view, the icon immediately to the right of a transport packet icon represents the payload.

1. Press the **F2** function key (if necessary) to display hierarchic view values in decimal base.
2. Double-click on the **PID 21** transport packet icon.

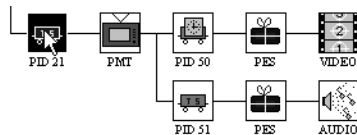

The analyzer opens the TS - Sample.trp -> PID 21 window.

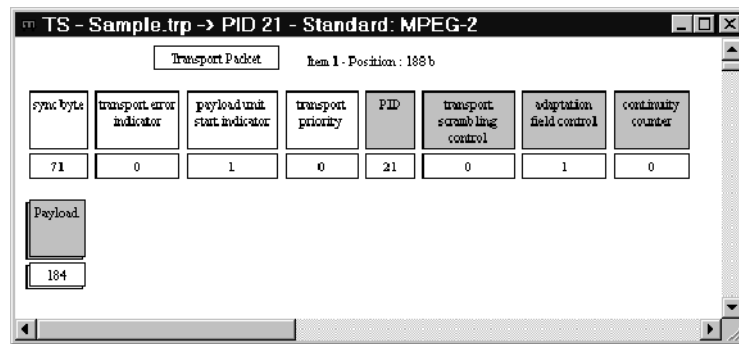

You can search for errors and get additional information about the fields and field values as you did with the transport packet at the TS level. The difference is you are now looking at only PID 21 packets, which contain the PMT sections that describe program one.

3. Click the **Last** command button in the lower toolbar to go to the last PID 21 packet in the transport stream. There are only 14 PID 21 transport packets in the *Sample.trp* stream.

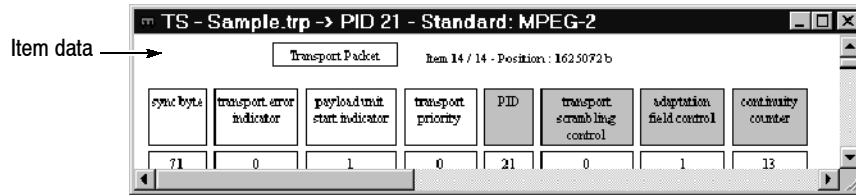

The item Position is the number of the first byte in the packet relative to the beginning (byte 0) of the transport stream file; there are 1625072 bytes in the file (and stream) before the last PID 21 packet.

As with the TS interpreted view, you can open a hexadecimal view of the packet through the Add View command button. Another way to look at the packets is in a binary view.

1. Click the **Add View** button.
2. Select **Binary** from the View Type submenu. The analyzer opens a window titled *TS - Sample.trp -> PID 21*.

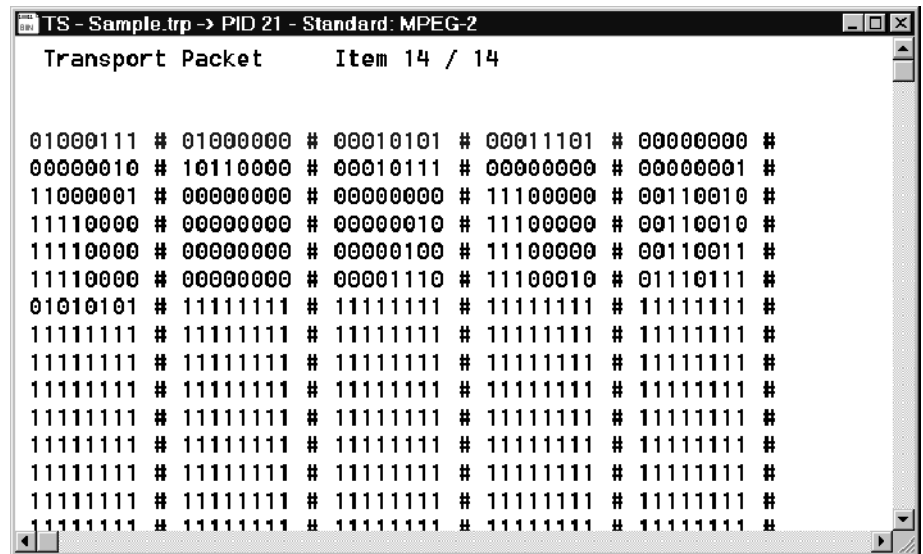

The first eight-bit byte, which corresponds to the sync byte (see the interpreted view on page 2-22), is 01000111; the binary equivalent of 71 decimal and 0x47 hex. The next three bits correspond to the following three packet fields, and the 13 bits after that (to the end of the third byte) correspond to the PID 0000 00010101 (which equals 21 decimal).

3. Close the *PID 21* interpreted and binary view windows.

## Exploring the PAT Icon

The PAT shortcut menu has two commands: Section and Check CRC.

**Section** PAT (Program Association Table) icons represent PAT sections, which are always contained in PID 0 transport packets. Use the following procedure to open an interpreted view of a PMT section.

1. Click on the hierarchic view **PAT** icon with the right mouse button. Hold the button down to open the shortcut menu.
2. Select **Section** from the shortcut menu to open an interpreted view of the PAT.

Item data →

Header fields →

table id	section syntax indicator	zero	reserved	section length	transport stream id	reserved	version number	current next indicator	section number	last section number
0	1	0	3	17	0	3	0	1	0	0

Program 0 information →

program number	reserved	network PID
0	?	16

Program 1 information →

program number	reserved	program map PID
1	?	21

Section CRC →

CRC
0xc109DE65?

---

**NOTE.** You can open the same interpreted view by double-clicking on the **PAT** icon.

---



You can do all the same things at the PAT section level that you can at the transport packet level. You can search for errors, get information on the fields and field values, and scroll among the PAT sections contained in the stream.

3. Close this window.

### Check CRC

The Analyzer automatically calculates and checks the CRC (cyclic redundancy code) of the first PAT section when opening a transport stream file. To check the CRC of every PAT section in the stream and compare it to the number coded into the section's CRC field, do the following:

1. Click on the **PAT** icon with the right mouse button and hold the button down to show the PAT shortcut menu.
2. Highlight the **Check CRC** command and release the button. Because there are no CRC errors in the *Sample.trp* PAT sections, the Analyzer displays the following dialog box:

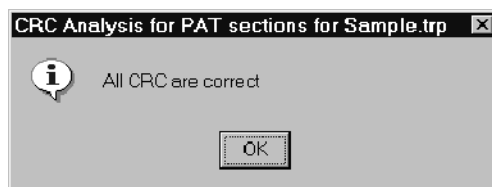

3. Click **OK** to close the dialog box.
4. The Message for... window also opened during the analysis. Dismiss this window and click **No** to close the Closing of the error message view dialog box. The purpose of the Message for... window is explained later.

## Exploring the PMT Icon

The MPEG-2 DVB/ATSC/ISDB-S/ARIB System Analyzer can perform several types of analyses on PMT (Program Map Table) sections.

**Section** Use the following procedure to open an interpreted view of a PMT section.

1. Double-click the on **PMT** icon to open an interpreted view of the first PMT section in the stream.

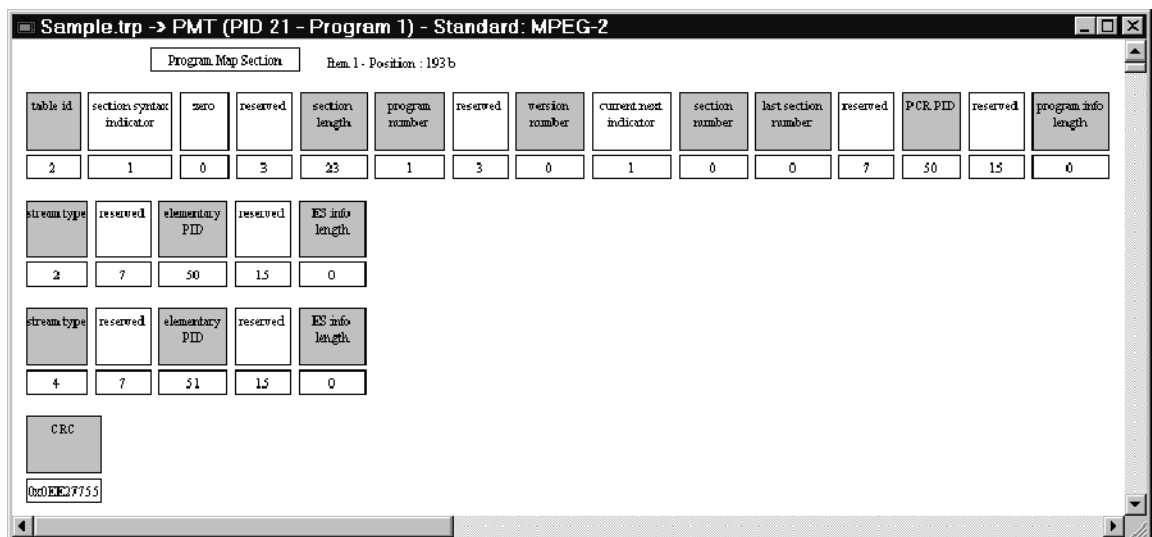

**Syntax Analysis** Syntax analysis checks all PMT sections in the stream for errors and variations from the standard. It searches for errors within the PMT itself and relative to the other tables (NIT and SDT for example).

1. From the Analysis menu select **Syntactic**.

The example does not have any PMT syntax errors.



2. Click **OK** to close the Syntactic Analysis for... window.
3. Dismiss the Message for... window and click **No** to close the Closing of the error message view dialog box.

The fact that the analyzer found no syntax errors in any of the PMT sections does not guarantee there are no such errors in the entire stream. To widen the search do the following:

- a. Click anywhere on the hierarchic view window or minimize the PMT interpreted view; the remaining, hierarchic view window is then automatically selected.
- b. Select **Syntactic** from the Analysis menu. This time, the analyzer searches the entire stream for errors and opens a Message for... window.

The Message for... window reports errors, warnings, and information about analyses performed in Hierarchic and Interpreted View windows.

- c. Select the Message for... window and type \* on the numeric keypad to expand the window. Note that all errors in this case are in one PES packet.

---

**NOTE.** For more information on the message window and error reporting, refer to Message Window on page 3-72.

---

4. Close the Message for... window.

During the Syntax analysis you may have noticed a message window similar to the following illustration. For most analyses performed in the hierarchic view, and for Go to searches performed in the interpreted view, pressing the Escape key interrupts the running process. Use this feature to terminate an analysis or search that becomes too lengthy. Click in the active window before executing the keystroke.

Perform a syntactic analysis  
PES packet level  
Press Escape to abort

### Check CRC

You can check the CRCs in all PMT sections through the shortcut menu just as you did with the PAT sections.

You can also check every CRC in the transport stream just like you checked the syntax of all items in the stream:

1. Select the hierarchic view.
2. Select **Check CRC** from the Analysis menu.

If CRC errors are found, the analyzer lists the errors in the Message for... window. Because *Sample.trp* contains no CRC errors, the analyzer reports that all CRC are correct.

3. Click **OK** (or press **Enter**) to dismiss the CRC Analysis... message window.
4. Close the interpreted view window and the Message for... window.

### PCR Analysis

PCR (Program Clock Reference) analysis allows you to see a graphical representation of the PCRs versus time.

1. Click on the **PMT** icon with the right mouse button and hold the button down to open the PMT shortcut menu.
2. Select **PCR Analysis** from the menu to open a window that diagrams the first ten clocks in the program. (Note: If the Transport Stream Property dialog box opens, click **OK** to accept the default Mux Rate.)

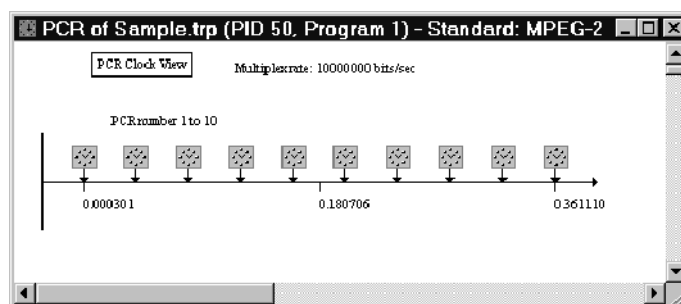

- Double-click on the third clock icon. This opens the PCR value box shown below.

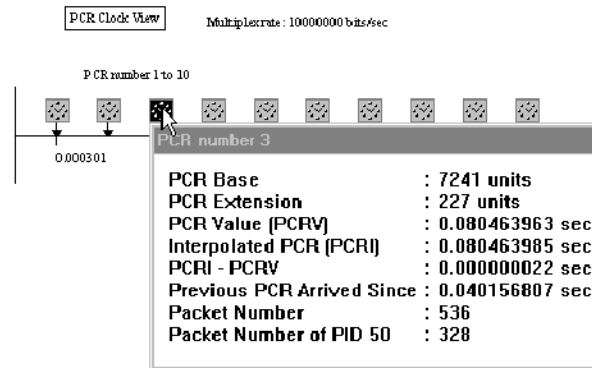

- Click anywhere in the PCR clock window to dismiss the value box.
- To display the values of all ten diagrammed PCRs at once, click the **Add View** command button in the upper toolbar.
- Select **PCR Values** from the View type submenu. The analyzer creates a window that lists the values for all ten PCRs in the diagram.

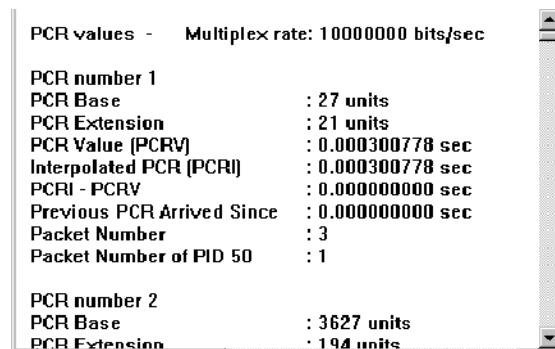

You can use the command buttons on the lower toolbar to navigate among the program PCRs.

- Click the **Next** command button to show the values of the next ten PCRs (numbers 11 through 20) in the stream.
- Select the original PCR of *Sample.trp* (PID 50, Program 1) window again. Notice that the diagram now shows PCRs 11 through 20.
- Close all windows except the hierarchic view.

### T-STD Analysis

T-STD analysis checks the selected program against the transport stream system target decoder model defined in the MPEG-2 standard.

---

**NOTE.** *The Dynamic Analysis algorithm uses the “Leak method” to transfer video elementary stream data from the main buffer, MBn, to the elementary stream buffer, EBn. Buffer overflow can occur when analyzing streams (such as those created with the MPEG Test System Multiplexer application) that require “VBV delay method” data transfer.*

*Refer to ISO/IEC 13818-1 for additional information about leak method and VBV delay method buffering.*

---

1. Select the **Options menu** and verify that Visual TSTD and LTW is check-marked.
2. Right-click the PMT icon and select **T-STD Analysis** from the shortcut menu.

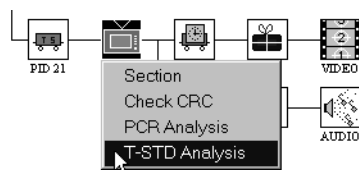

3. If a Transport Stream Property window opens, click **OK** to accept the multiplex rate and continue.

Because Visual TSTD and LTW mode is selected, the analyzer opens a T-STD Buffering Simulation window. The window contains dynamic bar graphs of the video, audio, and system buffers; the graphs show how full each buffer is at a given point in the simulation and also change color from blue to yellow to red as buffer overflow approaches and occurs. The simulation is not real-time and may take several minutes.

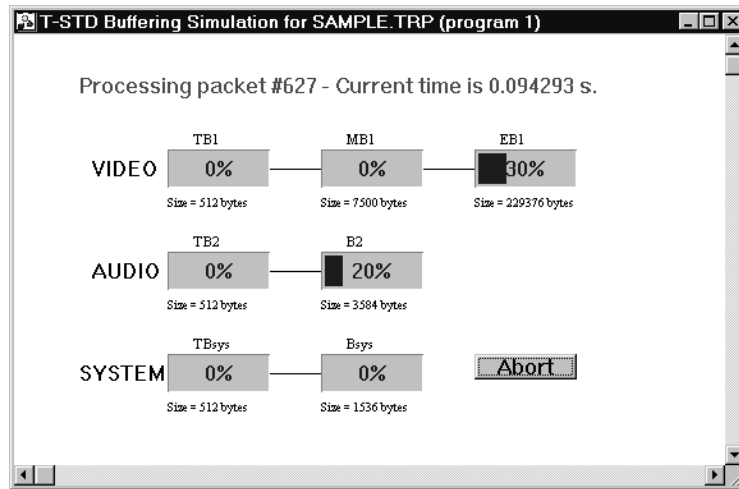

4. To terminate the simulation at any time, click the **Abort** button in the lower-right of the simulation window. The simulation pauses and you can choose to resume analysis or close the window.
5. Buffer overflows occur near the end of the Sample.trp simulation. To access an error report, select the Message for... window and type \* on the numeric keypad. You may have to move the buffering simulation window aside to gain access to the Message for... window.

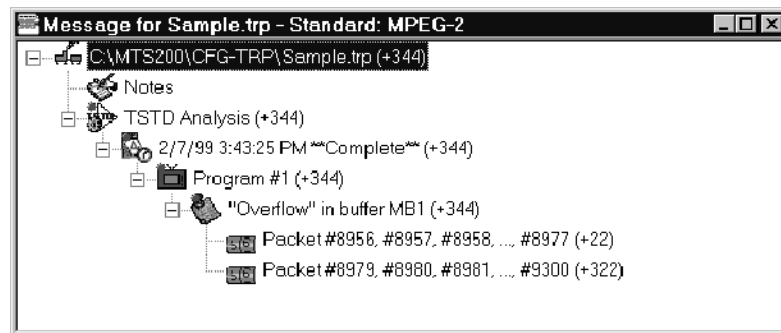

**NOTE.** For more information about the message window and error reporting, refer to Message Window on page 3-72.

6. Close all windows except the hierarchic view.

## Exploring the PES Packet Icon

The PES (Packetized Elementary Stream) packet icon represents all packets that, together, contain a given elementary stream. Individual PES packets are assembled from the payloads of several transport packets. You can learn more about the PES packets and their PTS/DTS (Presentation and Decode Time Stamps) through this icon.

- Interpreted View**
1. Double-click the **PES** icon immediately to the right of the PID 50 transport packet icon to open an interpreted view of the first video PES packet.

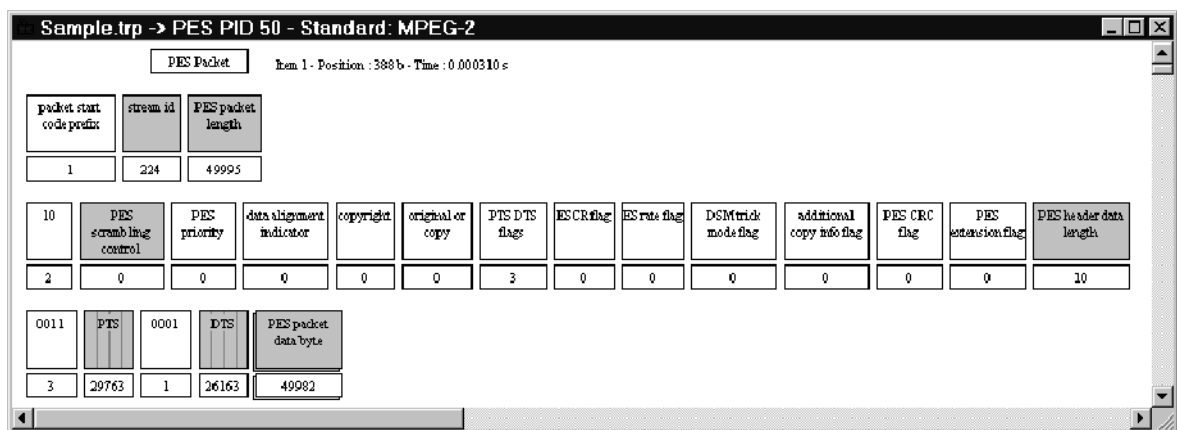

The Item data (near the top of the window) includes a *Time*: entry. This is the time, relative to the beginning of the transport stream, that the first byte of the packet appears in the stream. The time is included in all interpreted views that you open after performing an analysis involving a multiplex rate calculation. Both PCR analysis and T-STD analysis, performed through the PMT icon, involve a multiplex-rate calculation.

The current interpreted view offers the same options as the previous syntax analysis of the entire stream within the PID 50 PES packet.

2. Click the **Next Error** button on the lower toolbar. The program checks each packet in the stream for errors. If it finds an error, it jumps to the transport packet containing the error. There are several errors in the last PID 50 PES packet in Sample.trp. The errors are highlighted in red on the test system display.



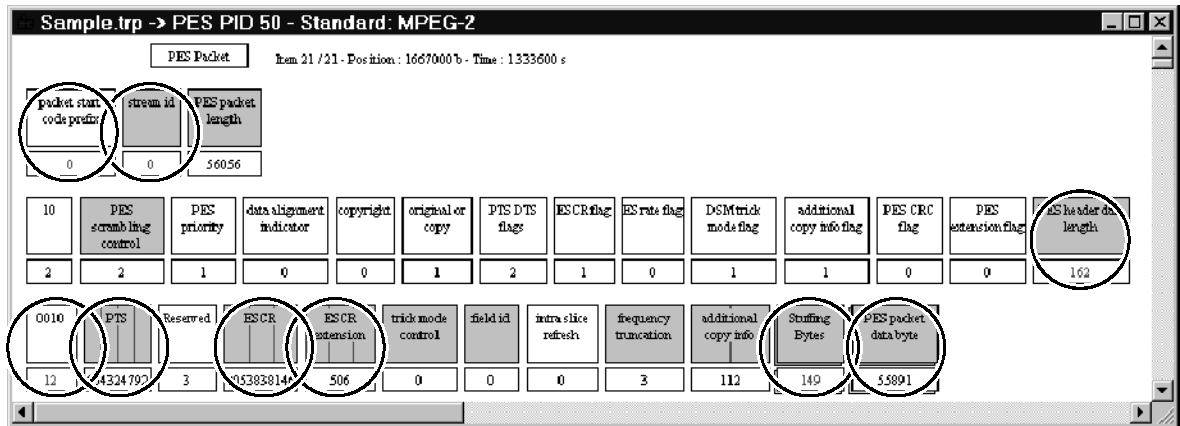

3. You can find out more about an error through the interpreted view. In the upper right corner of the view window, double-click on the **packet start code prefix** box to find out more about that field.

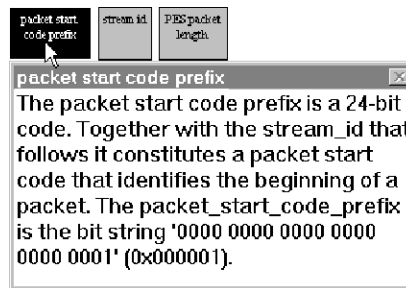

4. Read about the field and then click once outside the message window (but inside the interpreted view) to dismiss the message.
5. Now, double-click on the field value to see the value error message.

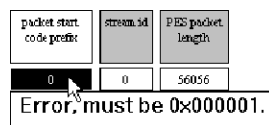

6. Close the interpreted view window.

**PTS/DTS** PTS/DTS analysis extracts the presentation and decode time stamps embedded in the elementary stream and shows their relative time positions in a graphical display window. With this display you can verify the logical sequence of all time stamps (the PTS must arrive later than the DTS and both must follow the associated data arrival for example) and check for the existence of B fields, which have no DTS.

1. Click on the **PID 50 PES** icon with the right mouse button and the button down to open the PES packets shortcut menu.
2. Highlight **PTS/DTS** and release the button. This opens a window containing a diagram of the first four PTS/DTS events in the elementary stream.

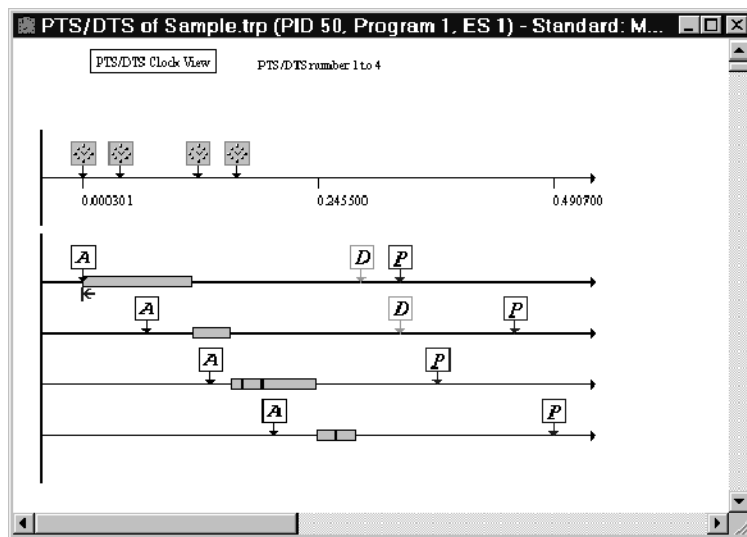

The preceding illustration reveals some errors in the *Sample.trp* PID 50 elementary stream:

- Three of the arrival times do not coincide with the start of the associated access unit.
- Two of the PTS/DTS events involve more than one access unit.

Both of these errors suggest problems in the encoding process. Below is a diagram from a correctly encoded stream.

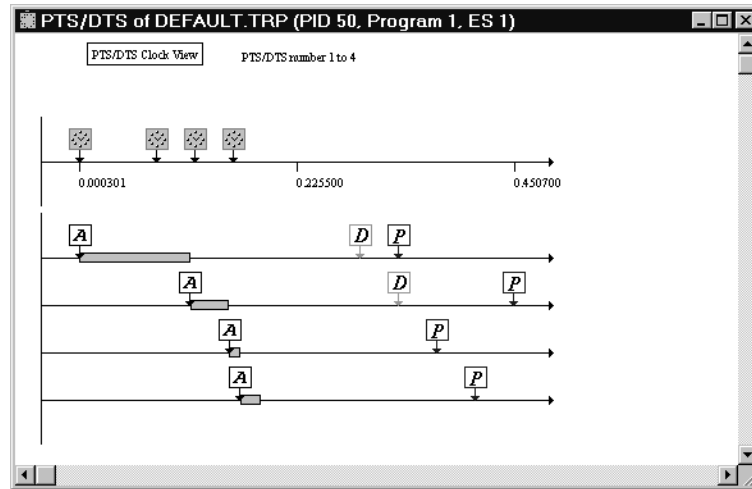

Table 2-2 lists and explains the icons used in the PTS/DTS diagram.

**Table 2-2: PTS/DTS graphic view icons**

Icon	Represents	Double-click for
	PCR (Program Clock Reference)	Time value of the PCR and location of the packet within the transport stream (TS packet number)
	Arrival time of the PTS/DTS	Arrival time value, time since the previous PTS/DTS arrived, and location of the packet (PES packet number) within the elementary stream
	DTS (Decode Time Stamp)	Time value of the DTS and location of the packet within the elementary stream (PES packet number)
	PTS (Presentation Time Stamp)	Time value of the PTS and location of the packet within the elementary stream (PES packet number)
	AU (Access Unit)	Begin time End time Size in bytes Type of frame (intra, predicted, or bidirection) Reference time
	Beginning of GOP	Not applicable

The example timing diagram illustrates several features of a correctly encoded MPEG-2 video stream:

- Access units arrive one after another, as you can see from the left side of the diagram.
  - The order of access unit decoding and presentation is visible in the right portion of the diagram.
  - Intra (I) and predicted (P) pictures must be decoded before presentation and therefore have both DTS and PTS. Bidirection (B) frames are decoded and presented at the same time and therefore have only presentation time stamps.
  - B frames use information in an associated P frame; the P frame must be decoded before the B frame(s) are decoded, but is presented after the B frame. In the example, the order of frame decoding is IPBB, but the order of presentation is IBBP.
3. Double-click on the first arrival icon to reveal its values.

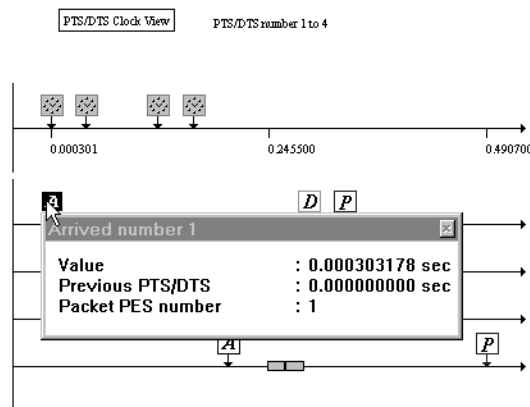

4. Click within the PTS/DTS window, but outside the value window, to dismiss the value window.

5. Double-click on the first AU icon to learn more about the access unit.

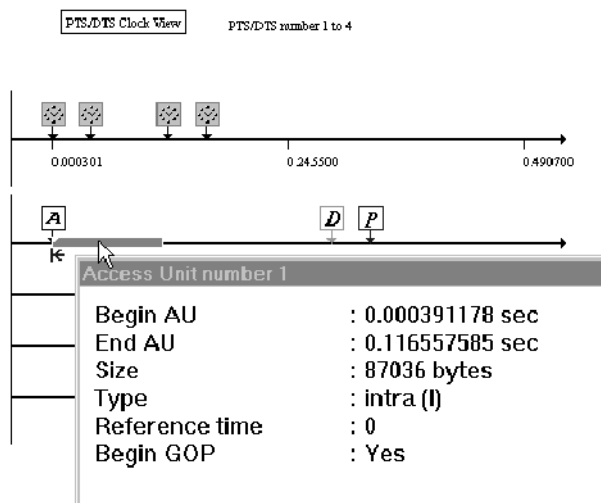

6. You can navigate among the time stamps of an elementary stream with the lower toolbar command buttons or the equivalent commands in the Edit menu.
7. Experiment using the lower toolbar command buttons to move among all the time stamps in the elementary stream (or at least that portion of the stream saved as Sample.trp).
8. Close all windows including the hierarchic view of Sample.trp.

## Viewing PSI/SI Data

You can access interpreted views of PSI, SI, PSIP or ISDB-S/ARIB tables using the following procedure. The specific menu selection depends on the standard used when you opened the active file: MPEG-2 (PSI), DVB (PSI/SI), ATSC (PSI/PSIP) or ISDB-S/ARIB (PSI/SI/ARIB).

1. Select **DVB** from the Options menu.
2. Open a DVB (Digital Video Broadcast) transport stream file if you have one available.
3. Select **PSI/SI** from the Selection menu. The PSI/SI Selection dialog box appears.

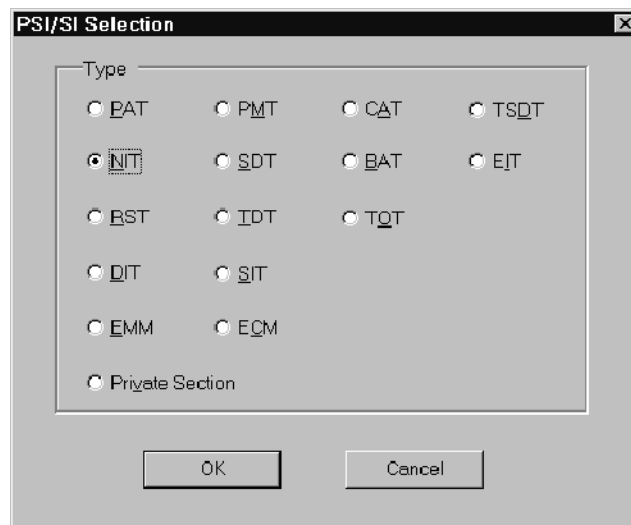

4. Select **NIT** and then click **OK** to open an interpreted view of the first NIT section in the stream. The exact appearance of the view will depend on the configuration of your particular DVB stream.

The screenshot shows a window titled "Dvb.trp -> NIT (PID 16) - Standard: DVB". It displays a "Network Information Table" for "Item 1 - Position: 187971 b". Below the title is a table with 17 columns representing various fields in the NIT. The data in the table is as follows:

table id	section syntax indicator	reserved future use	reserved	section length	network id	ISO reserved	version number	current next indicator	section number	last section number	DVB reserved	network descriptor length	descriptor	DVB reserved	transport stream loop length
64	1	1	3	26	0	3	0	0	0	0	15	13	13	15	0

Below the table, there is a "CRC" field with the value "0x7EB4E2E2".

---

**NOTE.** You can also open this view by double-clicking the NIT hierarchy icon or by selecting **Section** from the icon shortcut menu.

---

5. Double-click on a descriptor field, if the NIT contains them. The resulting descriptor message box contains an ASCII decode of the network information associated with the transport stream. You can use the same technique to view descriptor information in any DVB table in the stream.

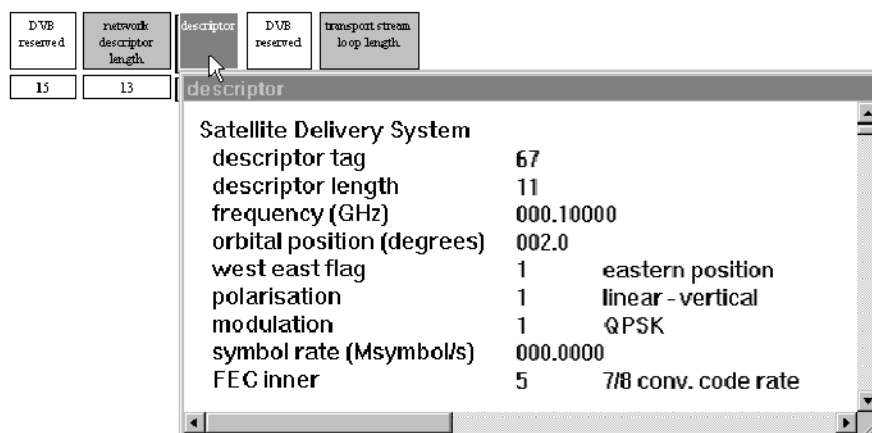

6. Close the NIT section window.

## Automatic Analysis

In the course of this tutorial, you have used the MPEG-2 DVB/ATSC/ISDB-S/ARIB System Analyzer to perform several kinds of analysis on various stream elements. The analyzer also has an automatic analysis feature that simplifies evaluation of the entire transport stream, yet still permits detailed analysis of many types of errors.

The following procedure requires that you have the hierarchic view of Sample.trp open on your analyzer display. If you closed that window, open Sample.trp again using MPEG-2 as the standard. Refer to page 2-11 to refamiliarize yourself with this process if necessary.

1. Select **Automatic analysis** from the Options menu. The Options for automatic analysis dialog box appears.

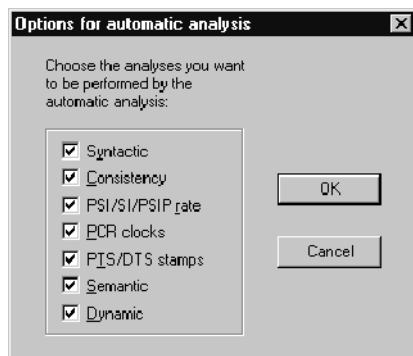

2. By default, automatic analysis includes all the listed tests. Automatic analysis takes several seconds to several minutes, depending on the size and complexity of the file, speed of your system, and the number and type of analyses selected through this dialog box. Dynamic analysis, the last selection in the dialog box, takes much longer than all other tests combined. If you are following this exercise to familiarize yourself with the analyzer, deselect Dynamic analysis.

---

**NOTE.** The MPEG-2 DVB/ATSC/ISDB-S/ARIB System Analyzer can conduct three kinds of Dynamic analysis: T-STD (transport stream target decoder), LTW (legal time window), and Smoothing Buffer. Automatic analysis includes only T-STD analysis; the remaining dynamic analyses must be performed manually. Refer to the Reference section of this manual for more information about Dynamic analysis.

---

3. Select **OK** to confirm the selections and close the dialog box.
4. Select **Automatic** from the Analysis menu.



5. Click **OK** in the Transport Stream Property window to accept the calculated multiplex rate and continue.

The Automatic analysis for *Sample.trp* window appears momentarily before being covered by the Message for Sample.trp window. The Automatic analysis for window lists the progress of each test. As the analysis proceeds, cells in the Status column change from blank to Running to Completed. As each test is completed, either OK or Errors (in red) appears in the corresponding Result cell. To view the Automatic analysis for... window during analysis, drag the Message for... window to a corner of the application window.

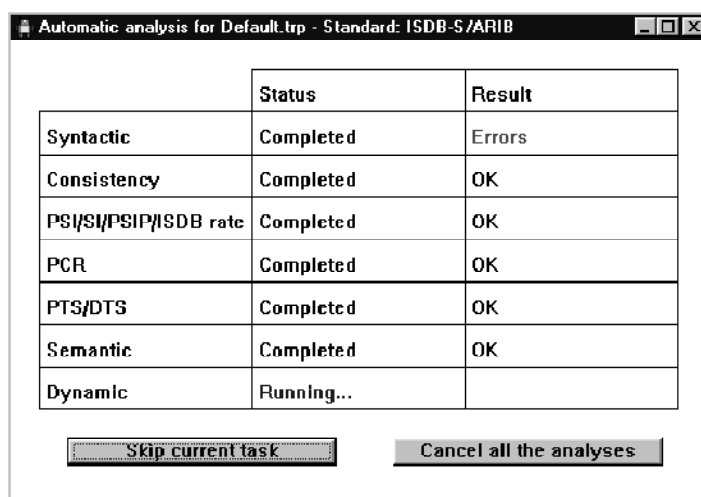

	Status	Result
Syntactic	Completed	Errors
Consistency	Completed	OK
PSI/SI/PSIP/ISDB rate	Completed	OK
PCR	Completed	OK
PTS/DTS	Completed	OK
Semantic	Completed	OK
Dynamic	Running...	

Buttons: Skip current task, Cancel all the analyses

**NOTE.** To end the Automatic analysis at any time, click **Cancel all the Analyses** in the bottom-right corner of the Automatic analysis for... window. To abort the current “Running” analysis, click **skip current task**.

During the analysis, the Message for... window opens to display progress and keep a record of errors, warnings, and information specific to each test. To fully expand the data in the Message for... window, select the window and type \* on the numeric keypad. To learn more about the Message for... window and error reporting, refer to page 3-72.

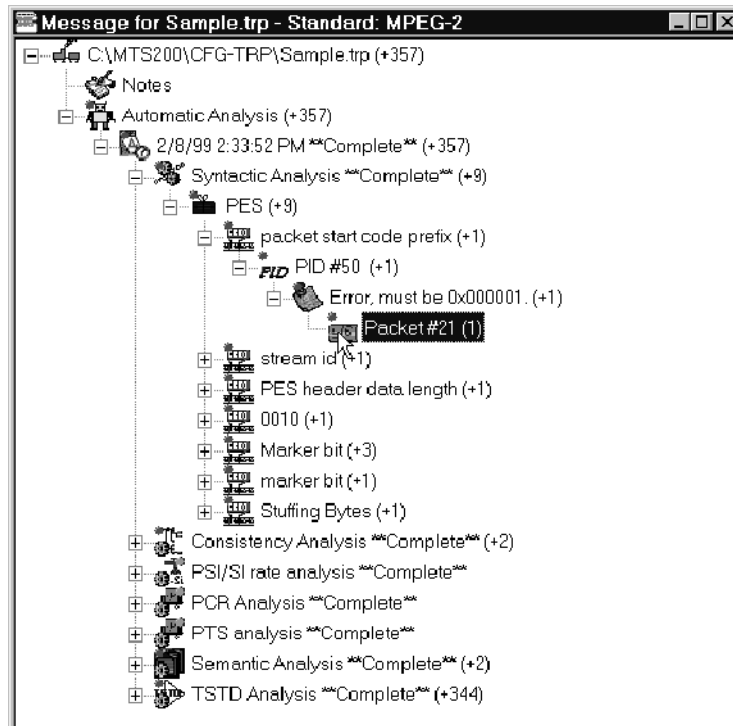

6. Double-click on a listed PCR, PTS/DTS, or semantic error to view additional details about an error. Double-clicking a listed syntax error, for example, opens an interpreted view of the item that contains the error. Red characters indicate syntax errors.

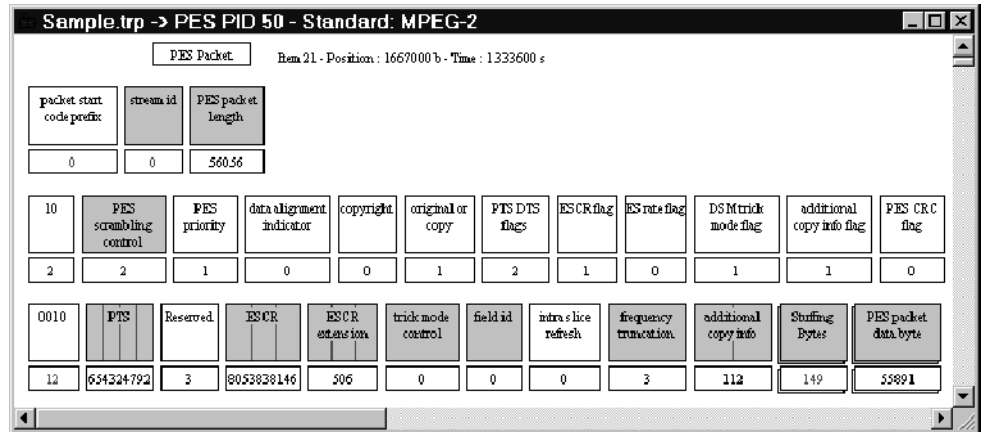

7. Use the following techniques to learn more from an interpreted view:

- Each block in the interpreted view represents a field of data. The field value (or number of bytes in a data field) appears below the field name. Press the **F2** key to toggle the value between decimal base and hexadecimal base.

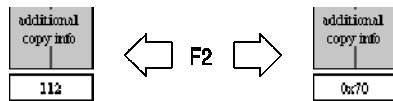

- Double-click on a field name for more information about the field.

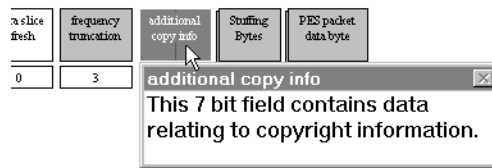

- Double-click on a data field name to add a hexadecimal view of the interpreted view.

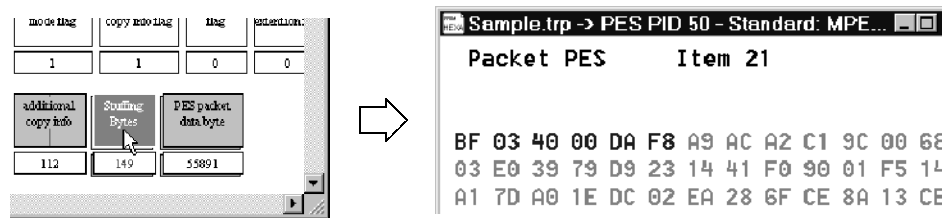

- Double-click on the field value/size to reveal additional information about the value and any errors.

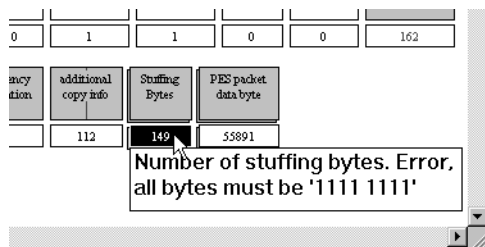

8. Return to step 6 and and explore some of the other error messages. The type of display and information available is the same as when the individual analysis is conducted manually (by selecting it from the Analysis menu). Refer to the *Reference* section for more information about each type of analysis.

## Quitting the Analyzer

This completes the tutorial for the MPEG-2 DVB/ATSC/ISDB-S/ARIB System Analyzer. Select **Exit** from the File menu to quit the application.



# Reference



# MPEG-2 DVB/ATSC/ISDB-S/ARIB System Analyzer

The MPEG-2 DVB/ATSC/ISDB-S/ARIB System Analyzer allows you to analyze MPEG-2 DVB, ATSC and ISDB-S/ARIB binary streams at the following levels:

- Transport stream (TS)
- Packetized Elementary Stream (PES)
- PSI (MPEG Program Specific Information), SI (DVB Service Information), and PSIP (ATSC Program and System Information Protocol) tables
- ISDB

The analyzer can perform three basic levels of analyses: Syntactic (structural), Semantic (coherence between all components of the multiplex), and Timing (PCR and PTS/DTS clock).

The analyzer demultiplexing function allows you to select and save transport and PES packets and PSI, SI, and PSIP tables. The analyzer is not designed to analyze the audio, video, or data contents of elementary streams, although you can extract and save these component to separate files for use in other applications. If the audio and video analyzer options are installed, you can begin an analysis of these elements with a right mouse click.

## Overview

The major functions of the Analyzer application are analysis, filtering, and information extraction (saving streams and stream components).

### Analysis

The application can analyze the following aspects of the MPEG transport stream and its embedded objects:

- Multiplex characteristic
- Cyclic redundancy code (CRC)
- Syntax or structure
- Consistency
- PSI/SI/PSIP/ISDB rate
- Program clock reference (PCR)
- Presentation and decoding time stamp (PTS/DTS)

- Semantics, or coherence among multiplexed components
- Mega-frame (MIP) coherence
- Dynamic T-STD, LTW, and smoothing buffer usage
- Entitlement management message (EMM) selection and diffusion (Option CA required)

For one-step analysis of most aspects of all levels of the MPEG data stream, you can also perform an Automatic analysis.

### **Filtering**

The MPEG-2 DVB/ATSC/ISDB-S/ARIB System Analyzer filters enable finding and viewing transport stream packets, PES packets, and PSI/SI/PSIP table sections that meet up to four criteria of your choosing. You can search for rare, significant, or troublesome stream items on the basis of these characteristics:

- Program ID (PID)
- The presence and value of up to three selected packet or section fields
- A sequence of up to four bytes
- The presence of the start of an elementary stream access unit

### **Saving Streams and Stream Components**

The analyzer gives you the ability to extract information from the binary stream and save it to a file for later use or analysis. This information includes the following:

- Transport packets
- PES packets
- PSI, SI, PSIP, and ISDB-S/ARIB tables
- Elementary streams

To save elementary stream data, double-click on the stream icon in the PSI hierarchic view. A Save as dialog box appears with the file type set to match the type of stream. Select the appropriate drive and directory, enter a file name, and click **OK**.

---

**NOTE.** You can also display video and audio elementary streams using the optional Video and Audio Stream Analyzers (if installed on your system).

---



## The Application Window

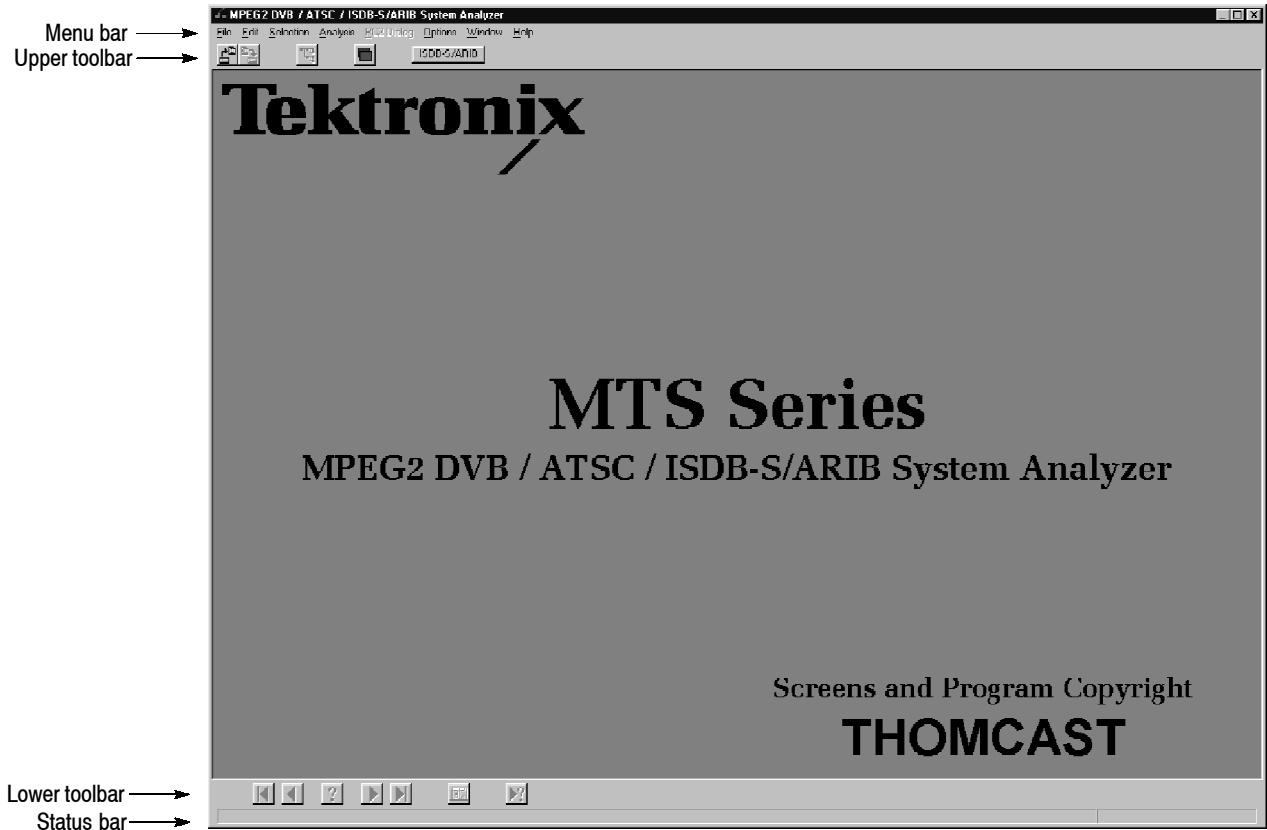

All analyzer functions occur within the application window. The menu bar is immediately below the window title and provides access to the various analyzer commands. The upper toolbar, immediately below the menu bar, and the lower toolbar, below the application workspace, provide direct access to commonly used menu commands. The status bar, on the bottom of the window, displays information about the various menu commands and command buttons.

**Menu Bar** The Menu bar provides access to the main analyzer menus.

**File Menu.** The File menu controls the analyzer-disk interface. The commands in this menu operate as in all Windows applications. See *Opening a File* (page 3-14) and *Extracting and Saving Stream Elements* (page 3-65) for more information on opening various MTS300 file types and saving transport stream data to files.



**Table 3-1: File menu commands**

Use	To
Open	Open an existing transport stream, packet, or PSI/SI/PSIP/ISDB file
Save as	Save the current selection to disk
Print	Print the current view
Printer setup	Change printer settings
Exit	Quit the Analyzer application

**Edit Menu.** Use the Edit menu to navigate among sections of a stream or objects embedded in a stream. These commands duplicate the actions of the command buttons on the lower toolbar.

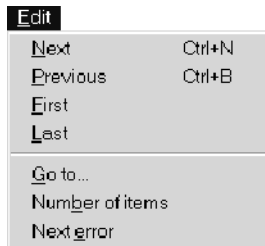

The buttons are shown below, from left to right: First, Previous, Go to, Next, Last, Number of items, and Next error.



**Table 3-2: Edit menu commands**

Use	To
Next	Go to the next item (PAT, transport packet, PES packet, table section...)
Previous	Go back to the previous item
First	Go to the first item

**Table 3-2: Edit menu commands (Cont.)**

Use	To
Last	Go to the last item
Go to	Go to a selected item
Number of items	Count and display the number of items
Next error	Locate and display the next item that has at least one syntax error

**Selection Menu.** The Selection menu provides access to several different views of stream data on several different levels.

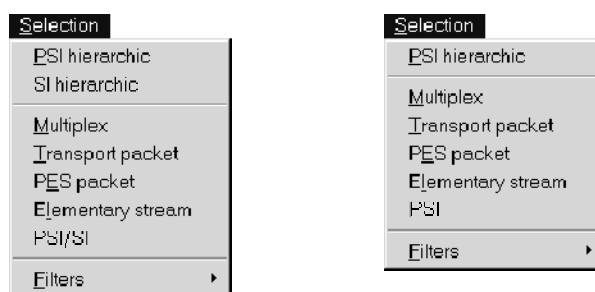
**Table 3-3: Selection menu commands**

Use	To
PSI hierarchic	Create a new hierarchic view of the transport stream represented by the selected window.
SI hierarchic	Display an SI (DVB) hierarchic view of the transport stream; this command is present only when DVB is selected in the Options menu.
PSIP hierarchic	Display a PSIP (ATSC) hierarchic view of the transport stream.
Multiplex	Display an interpreted view of the transport packets (all PIDs). This command is equivalent to double-clicking on the TS (engine and tender) icon and is not available when a hierarchic view is selected.
Transport packet	Display an interpreted view of the transport packets of a specified PID.
PES packet	Display an interpreted view of the PES packets encoded in the transport packets of a specified PID.
Elementary stream	Extract an elementary stream and save it to a file.
PSI/SI or PSI	Display an interpreted view of the specified PSI/SI sections; SI only present when DVB is selected in the Options menu.
PSI/PSIP	Display an interpreted view of the specified PSI/PSIP sections.
PSI/SI/ISDB	Display an interpreted view of the specified PSI/SI/ISDB sections.
Filters	Open the Filters submenu.

**Filters Submenu.** The Filters submenu enables extraction of transport stream components or objects that meet user-specified criteria. Refer to *Filters*, beginning on page 3-56, for a complete explanation.

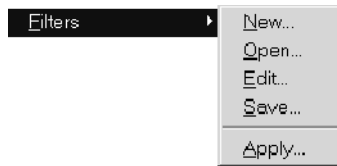

**Table 3-4: Filters submenu commands**

Use	To
New	Create a new filter
Open	Open an existing filter (*.flt) file
Edit	Modify a filter
Save	Save a filter to disk (*.flt) file
Apply	Apply a filter to the stream represented by the selected hierarchic view

**Analysis Menu.** Use the Analysis menu commands to analyze stream contents and characteristics either automatically (selected analyses one after another) or manually (one analysis at a time).



DVB mode

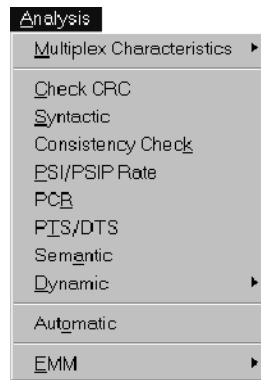

ATSC mode

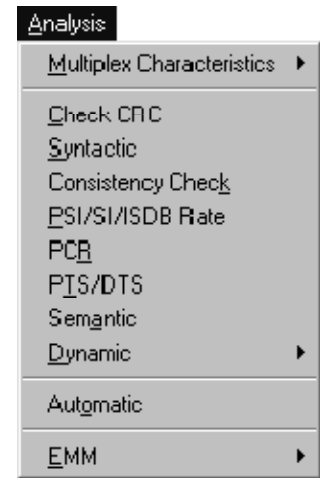

ISDB-S/ARIB mode

**Table 3-5: Analysis menu commands**

Use	To
Multiplex Characteristics	Open the Multiplex Characteristics submenu
Check CRC	Check CRCs of the various tables in the selected PSI hierarchy ( <i>Check CRC</i> begins on page 3-31)
Syntactic	Check the stream for syntax errors ( <i>Syntax Analysis</i> begins on page 3-33)
Consistency Check	Check for consistency within the stream ( <i>Consistency Check</i> begins on page 3-34)
PSI/SI, PS/PSIP, or PSI/SI/ISDB Rate	Analyze the rates of the various PSI/SI/PSIP tables within the stream ( <i>PSI/SI/ISDB-S/PSIP Rate Analysis</i> begins on page 3-37)
PCR	Check the program clock references in the stream ( <i>PCR Analysis</i> begins on page 3-38)
PTS/DTS	Check the time stamps in a selected elementary stream ( <i>PTS/DTS Analysis</i> begins on page 3-41)
Semantic	Check all transport packets for semantic errors ( <i>Semantic Analysis</i> begins on page 3-45)
Mega-frame (MIP)	Check the fields and syntax and semantic control of the selected mega-frame initialization packets of the DVB stream
Dynamic	Open the Dynamic (analysis) submenu
Automatic	Perform an automatic sequence of analyses ( <i>Automatic Analysis</i> begins on page 3-54)
EMM	Open the EMM submenu

**Multiplex Characteristics Submenu.** The Multiplex Characteristics submenu provides access to multiplex-related information.

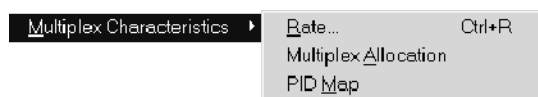

**Table 3-6: Multiplex Characteristics submenu commands**

Use	To
Rate	Display the overall multiplex rate as calculated from the first ten PCRs and, if the calculated rate is incorrect, enter the correct value ( <i>Multiplex Rate</i> begins on page 3-29)
Multiplex Allocation	Display a pie chart of PID allocation in the stream ( <i>Allocation</i> begins on page 3-30)
PID Map	Display the sequence of PIDs in the transport stream ( <i>PID Map</i> begins on page 3-31)

**Dynamic Submenu.** The Dynamic analysis submenu contains selections for dynamic analysis of the MPEG bit stream.



**Table 3-7: Dynamic submenu commands**

Use	To
T-STD	Conduct a transport stream system target decoder simulation ( <i>T-STD Analysis</i> begins on page 3-48)
LTW	Check the effect of LTW (legal time window) offset and piecewise rate field values ( <i>LTW Analysis</i> begins on page 3-52)
Smoothing Buffer	Conduct a smoothing buffer simulation ( <i>Smoothing Buffer</i> begins on page 3-54)

**EMM Submenu.** Use this menu to specify EMM analysis parameters used during processing.



**Table 3-8: EMM submenu commands**

Use	To
EMM selection	Specify EMM types and transport packet portion
Diffusion rate	Specify EMM PID number

**Table 3-8: EMM submenu commands (Cont.)**

Use	To
Diffusion holes	Specify EMM PID number and hole length
Discontinuity	Specify EMM PID number and discontinuity type

**PC2 dialog Menu.** This menu sends Viaccess ECMs and EMMs to a PC2 card. See page 3-77 for additional information. You must install Option CA (Conditional Access) software to use this command.

**PC2 dialog****Table 3-9: PC2 dialog menu commands**

Use	To
PC2 dialog	Send EMM or ECM selection to the PC2 card

**Options Menu.** Use the Options menu to set various analyzer options and to save and restore program configurations. Refer to *The Options Menu*, on page 3-68, for more information.

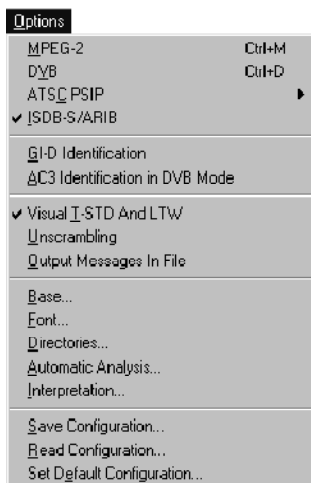

**Table 3-10: Options menu commands**

Use	To
MPEG-2	Specify MPEG-2 as the standard to open a new file
DVB	Specify DVB as the standard to open a new file
ATSC PSIP	Open the ATSC PSIP submenu
ISDB-S/ARIB	Specify ISDB-S/ARIB as the standard to open a file
Visual TSTD and LTW	Switch the graphic view of TSTD and LTW dynamic analysis on/off
Unscrambling	Switch the Unscrambling option on/off
Output messages in file	Switch the output message option on/off
Base	Specify the numeric base (decimal or hexadecimal) used in the interpreted and hierarchic views
Font	Specify the text font (typeface and size) used in analyzer views
Directories	Configure default directories
Automatic Analysis	Configure automatic analysis (specify the analyses to perform)
Interpretation	Configure the interpreted view
Save configuration	Save the current user configuration to a file
Read configuration	Read and apply a previously saved user configuration
Set default configuration	Reset all options to the default settings

**ATSC PSIP Submenu.** Use this menu to specify ATSC PSIP Standards options.

**Table 3-11: ATSC PSIP submenu commands**

Use	To
Terrestrial	Specify ATSC PSIP Terrestrial as the standard to open a new file
Cable	Specify ATSC PSIP Cable as the standard to open a new file



**Window menu.** Use the Window menu to manage the various analyzer windows.

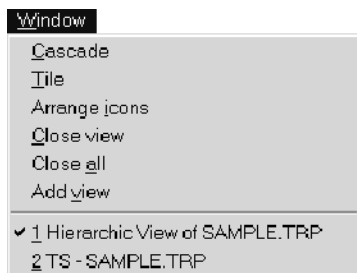

Command operation is identical to all other Windows applications, with the exception of Add view. Use Add view to create a new window that displays current window data in a different format. A small submenu, like those shown below, appears when you select Add view.

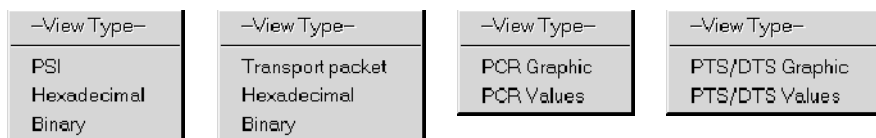

**Table 3-12: Add view menu commands**

Use	To
(the first choice)	Create a duplicate of the selected view
Hexadecimal	Create a byte-by-byte, hexadecimal view of the data
Binary	Create a bit-by-bit, binary view of the data
(PCR or PTS/DTS) Values	Create a view that lists numeric values related to the clock or time stamp

**Help Menu.** The Help menu provides standard Windows and application-specific information.







**Table 3-13: Help menu commands**

Use	To
Contents	Open a Help window and display the table of contents
Using help	Provides general information on how to use the Help system
About...	Display the application version and copyright

**Upper Toolbar**

The following table lists the command buttons found on the upper toolbar. Click the appropriate button to select one of these functions:



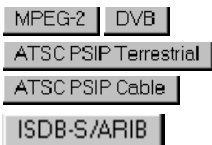



**Table 3-14: Upper toolbar commands**

Icon	Name	Function
	Open	Open an existing stream. Equivalent to the Open command in the File menu.
	Save as	Save streams and stream elements. Equivalent to the Save As command in the File menu.
	PSI Hierarchy	Display the hierarchic structure of the current PSI. Equivalent to the PSI hierarchic command of the Selection menu.
	View	Create a new window similar to the current window. Selecting this icon opens a submenu that offers a choice of window display modes. This selection is similar but not equivalent to the Add view command in the Window menu.
	Standard to open new file	Specify the standard to open a new file: MPEG-2, DVB, ATSC PSIP Terrestrial, ATSC PSIP Cable. Selections identical to those found in the Options menu.

**Lower Toolbar**

The commands from the lower toolbar are only available if the selected document window contains specific items (stream packets, transport tables, elementary stream packets, PES, or PSI, SI DVB ATSC PSIP and ISDB-S/ARIB table sections). When the document window does not contain any of these items, the command buttons are not available. Click the appropriate command button to implement one of the functions described in table 3-15.

**Table 3-15: Lower toolbar commands**

Icon	Name	Function
	Start	Accesses the first item. Equivalent to the First command in the Edit menu
	Previous	Selects previous item. Equivalent to the Previous command in the Edit menu
	Go To	Goes directly to an item. Equivalent to the Go to command in the Edit menu
	Next	Selects the next item. Equivalent to the Next command in the Edit menu
	End	Goes to the last item. Equivalent to the Last command in the Edit menu
	Number	Displays the number of items. Equivalent to the Number of items command in the Edit menu
	Error	Finds and displays the next item that contains at least one syntax error. Equivalent to the Next Error command in the Edit menu

**Status Bar**

The left side of the Status Bar displays a brief explanation of a menu entry when you position the cursor over a menu selection in the Menu bar. The right side of the Status Bar displays the selected standard (MPEG-2, DVB, ATSC, ISDB-S/ARIB) for the current active window.

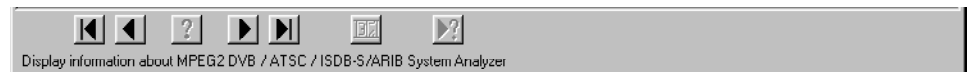
**The Escape Key**

You can terminate most activities performed by the analyzer with the Escape key, which is located in the upper left-hand corner of the keyboard. When you press this key, the current activity will terminate as soon as possible and the analyzer will display the available results. Use this feature to terminate an analysis in the hierarchic view or a Go to search in the interpreted view that becomes too lengthy.

If the requested activity can be terminated, a message similar to one shown below appears when you initiate the activity. Select the active window and press the **Esc** key to terminate the activity.

Perform a syntactic  
analysis  
Press Escape to abort

## Opening a File

The MPEG-2 DVB/ATSC/ISDB-S/ARIB System Analyzer can open MPEG-2 transport stream files (\*.trp, \*.bin, or \*.ts file extensions), PES packet files (\*.pes extension), and section files (\*.si extension).

To open a file, select **Open** from the File menu, click the  command button in the upper toolbar, or type **CTRL+O**.

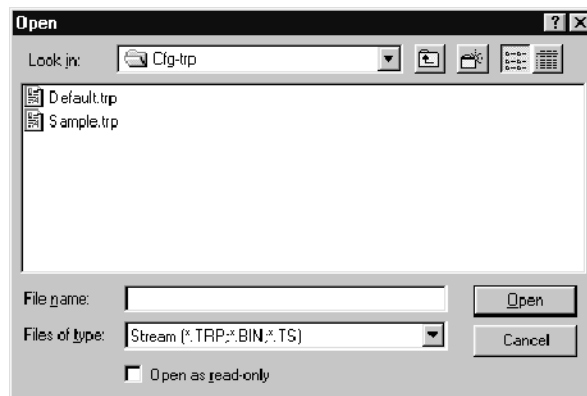

In the Open dialog box, do the following:

1. Select the appropriate drive, directory, and file type. Sample files are in the c:\MTS300\Cfg-trp directory.
2. Select the file to open from the files list.
3. Double-click on the file name, click the **OK** button, or press **ENTER**.

When you open a transport stream file, a hierarchic view appears in the application window. If you open a transport packet, PES, or section file, an interpreted view appears.

**Table 3-16: File type definitions**

File type	Definition
Stream	Transport stream file consisting of a packet of 188 bytes beginning with 0x47. The analyzer performs an automatic synchronization on the first three valid packets.
Transport Packet	
PES Packet	PES packet file consisting of packets beginning with 0x000001 start code. The analyzer performs an automatic synchronization on the first valid start code.
PSI/SI/PSIP/ISDB-S/ARIB Section	Section file beginning with a table as the first byte.

## The Hierarchic View

When you open a multiplex file in the application window, a hierarchic view appears. The hierarchic view uses icons to show the interrelationship of stream components and is the starting point for many types of analyses. With the hierarchic view, you can contextually select, display, and analyze specific portions of the transport stream. Some items (and their icons) apply only to DVB, ATSC, or ISDB-/ARIB streams and appear only when DVB, ATSC, or ISDB-/ARIB options are selected from the Options menu

**Icon menus.** Each icon type in the hierarchic view has a context-specific shortcut menu. These menus allow quick access to the functions specifically available for the chosen element. To display a popup menu, click on the the icon with the right mouse button. Hold the button down, highlight the desired command, and release the button to select the command. You can select the first command on a menu by double-clicking on the icon.

Some example menus are shown below. Menu entries vary by icon type and the standard selected in the Options menu (MPEG-2, DVB, ATSC PSIP).

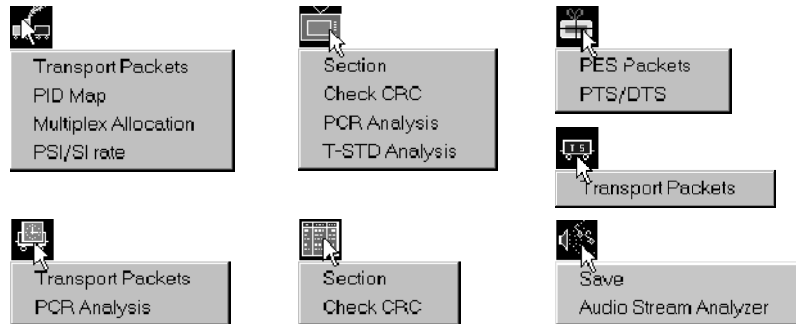

**Double-click for an interpreted view.** You can double-click on a table icon to display an interpreted view of the table section. For additional information on the interpreted view, refer to *The Interpreted View* on beginning on page 3-23.

**Scrambling Information.** If a portion of the stream is scrambled, the base icon incorporates the lock symbol.

Transport stream and packetized elementary stream scrambling is identified at the following levels:



**PSI Hierarchic View**

The figure below shows the PSI hierarchic view of a simple MPEG-2 transport stream.

When you open a stream, a consistency analysis is performed on the first 3,000 valid transport packets of the file and the results displayed.

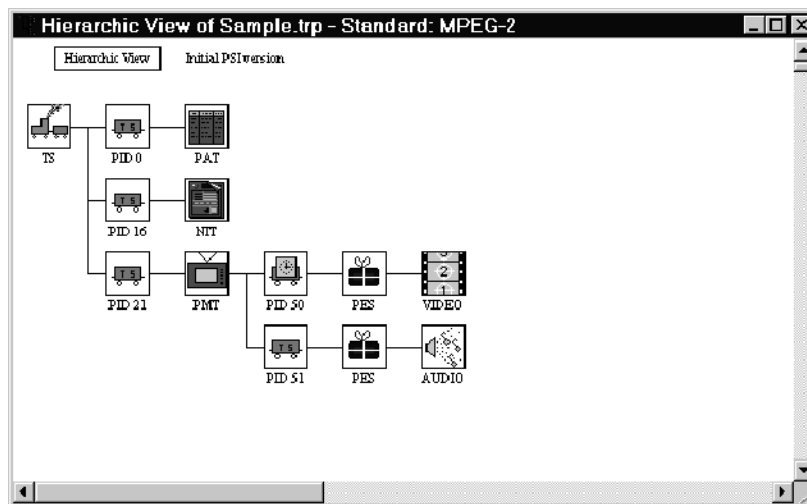





The analyzer can generate a hierarchic view only if the stream contains a PAT (program allocation table, PID 0) or PMT (program map table).













The hierarchic view that appears when you first open a file is based on the first versions of the PAT and PMT tables found in the stream. Use the **Next** command in the Edit menu, or click on the Next command button (in the lower toolbar), to go to the next PSI version, if any, in the stream.

**Stream Elements and Icons.** Hierarchic view icons represent the various elements that make up or are embedded in the transport stream.

**Table 3-17: Icons used in the PSI hierarchic view**





Icon	Element type
 TS	Multiplex transport packets. This icon represents all (188/204/208-byte) transport packets that make up the stream.
	Transport packets of a particular PID (Program ID). Other elements (tables, clocks, PES packets) are the payload contained within transport packets or are constructed from the payload of several transport packets that have the same PID. The PID number appears under the icon.
	Transport Packets that contain independent PCR clocks. The PID appears under the icon.
 PAT	PAT (Program Association Table) sections. Always contained in PID 0 transport packets.
 CAT	CAT (Conditional Access Table). The CAT table allows you to associate one or more conditional access systems with the transport stream.

**Table 3-17: Icons used in the PSI hierarchic view (Cont.)**

Icon	Element type
 PMT	PMT (Program Map Table) sections.
 NIT	NIT (Network Information Table). Provides access to MPEG-2 PSI, DVB SI, ATSC PSIP, and ISDB-S/ARIB program and service information tables through the PSI/SI/PSIP commands in from Selection menu. Also used for Private Data sections.
 PES	PES (Packetized Elementary Stream). This icon represents all packets that, together, contain a given elementary stream. Individual PES packets are assembled from the payloads of several transport packets.
 VIDEO	MPEG video elementary stream.
 GLD	Digicipher II video elementary stream.
 AUDIO	MPEG audio elementary stream.
 AC-3	Dolby Digital (AC-3) audio elementary stream. (DVB and ATSC modes only)
 AAC	AAC (Advanced Audio Coding) audio elementary stream.
 DATA	DATA (data elementary stream).
 MIP	MIP (mega-frame initialization packet). Special DVB-T transport packets in PID 21 (0 x 15).
 DSM CC/D	DSM CC (Digital Storage Media Command and Control).
 ECM	ECM (entitlement control message) sections.
 EMM	EMM (entitlement management message) sections.

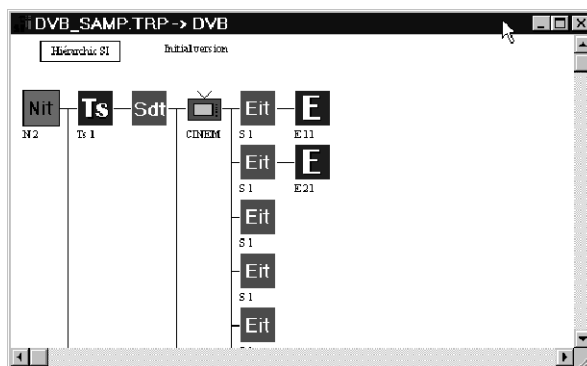

**Table 3-18: Special hierarchic view symbols**

Symbol	Significance
	The question mark is added to a TS icon when the transport packets have undefined PIDs and are not referenced by any PSI table. (This is permissible in MPEG-2, but may indicate a PSI configuration problem).
 	The lock symbol, superimposed on an icon, indicates that part of the stream is scrambled. Scrambling on the transport stream level is indicated by a lock on the TS (rail car) icon and the following PES and ES icons; scrambling on the PES level is indicated by a lock only on the PES and ES icons.
	A red square (border) surrounding a base icon after a Consistency analysis indicates that the data type, declared in a PSI table, is not valid.
	A red X over a base icon as a result of Consistency analysis indicates that a specific PID, declared in a PSI table, cannot be found in the transport stream.



**SI (DVB) Hierarchic View**

If the open transport stream file contains DVB SI tables, you can use the SI hierarchic command in the Selection menu to display an SI hierarchic view.









**Stream Elements and Icons.** The SI hierarchic view uses the icons described in the table below.

**Table 3-19: Icons used in the SI hierarchic view**

Icon	Element type
	Nit (Network information table) sections.
	Sdt (Service description table) sections.

**Table 3-19: Icons used in the SI hierarchic view (Cont.)**

Icon	Element type
	S (Service information) sections.
	Eit (Event information table) sections.
	Bat (Bouquet association table) sections.
	Transport stream referenced in NIT and BAT tables.
	Event referenced in an EIT table.
	TV service referenced in a SDT table.
	Radio service referenced in a SDT table.
<b>Txt</b>	Teletext service referenced in a SDT table.

**NOTE.** Use the *Next* command in the *Edit* menu, or click on the *Next* command button (in the lower toolbar), to go to the next SI version, if any, in the stream.



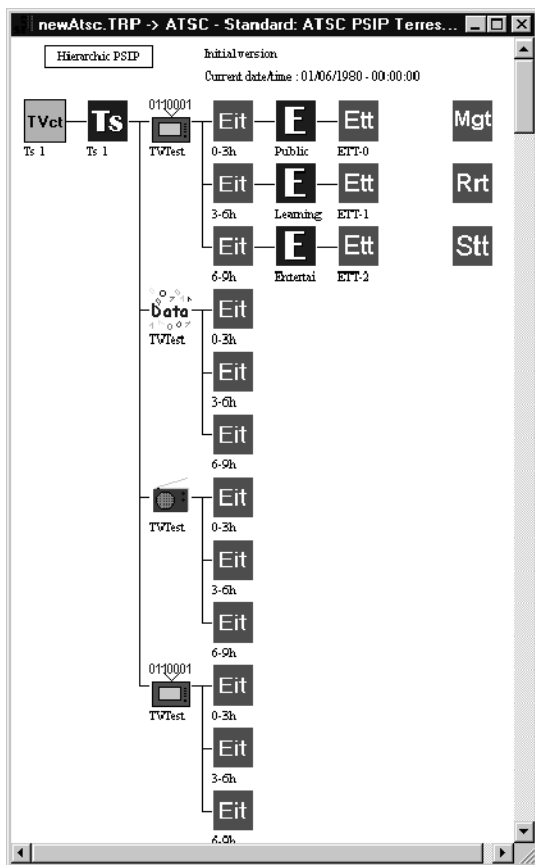

### The PSIP (ATSC) Hierarchic View

If the open transport stream file contains ATSC PSIP tables, you can use the PSIP hierarchic command in the Selection menu to display a PSIP hierarchic view.











**Stream Elements and Icons.** The PSIP hierarchic view uses the icons described in Table 3-20.

**Table 3-20: Icons used in the PSIP hierarchic view**

Icon	Element type
	Mgt (Master guide table) sections.
	TVct sections.
	CVct (Cable virtual channel table) sections.
	Eit (Event information table) sections.
	Ett (Extended text table) sections.

**Table 3-20: Icons used in the PSIP hierarchic view (Cont.)**

Icon	Element type
	Transport stream referenced in TVCT and CVCT tables.
	Event referenced in EIT and or ETT tables.
	Digital TV virtual channels referenced in VCT tables
	Analog TV virtual channels referenced in VCT tables.
	Radio virtual channels referenced in VCT tables.
	Rrt (Rating Region Table) sections.
	Stt (System time table) Sections.
	Data virtual channels referenced in the VCT table.
	Virtual channels referenced in VCT tables but of unknown type or an unreferenced channel.

**NOTE.** Use the *Next* command in the *Edit* menu, or click on the *Next* command button in the lower toolbar, to go to the next PSIP version, if any.

## The Interpreted View

The interpreted view provides access to the various fields and syntax and semantic control functions within the transport stream.

To create the interpreted view, double-click on one of the multiplex element icons in the hierarchical view, such as a transport packet, packetized elementary stream, mega-frame initialization packet, or table section. If errors are detected in the interpreted view, erroneous fields (and their values) appear in red.

The interpreted view of a transport stream packet is shown below.

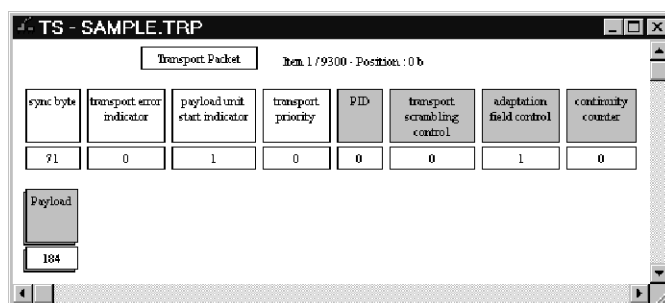

### Item Information

The currently interpreted packet or section is called an “item.” Information about the items relationship to other items and position in the transport stream appears near the top of the interpreted view window.

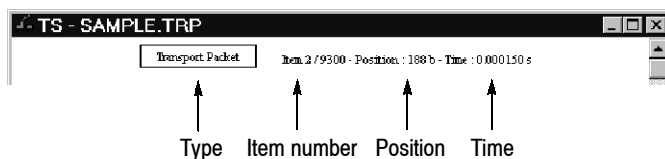

Item information includes the following:

- The item number is the position of the current item relative to all such items in the transport stream. The total number of items (9300 in the example) is displayed if you used a command button (in the lower toolbar) to go to the last item or to count the items in the stream. You can also use command buttons to move back and forth among the items and to search for an item with a syntax error. Refer to *The Lower Toolbar*, on page 3-13, for more information.

- The position is that of the first byte in the item relative to the beginning of the transport stream. The example item is the second 188-byte packet in the stream; it begins with byte 188.
- The time is relative to the beginning of the stream and is displayed after a multiplex rate calculation. Perform a multiplex rate calculation by selecting it from the Multiplex characteristics submenu of the Analysis menu or by typing **CTRL+R**. The analyzer also performs the calculation as part of several other analyses, including PCR, PSI/SI rate, PTS/DTS, and Dynamic.

**Fields**

The interpreted view shows the fields of information and data that make up the section or packet. Each field is represented by a name box and a value rectangle below it. Fields vary in length from one bit to many bytes. The width of each box/rectangle does not indicate the length of the field. You can configure the interpreted view, through the Interpretation command on the Options menu (see page 3-26), to show the length or position (in bits) of each information field. The length or position is indicated below the value rectangles.

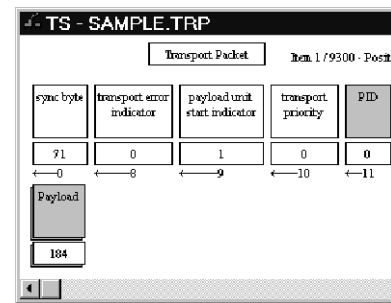
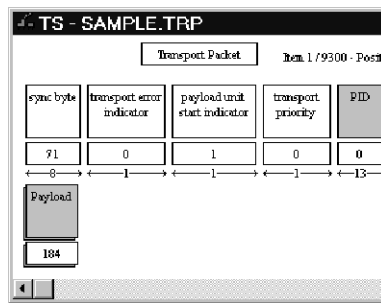

The length of data fields, such as the Payload in the above windows, is always shown (in decimal number of bytes) in the value rectangle. Value rectangles of information fields contain the value of the field. To switch information field values (but not data field lengths) between decimal and hexadecimal base, press the **F2** key.

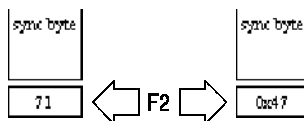

Double-click on the name box for an explanation of a field.

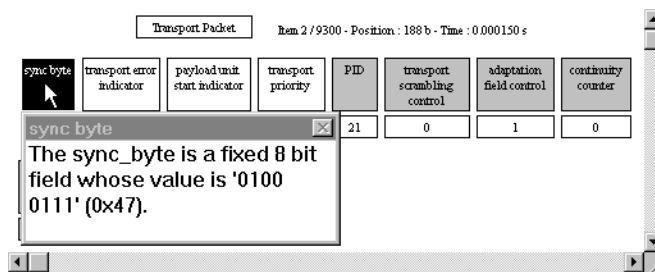

Double-click on the value rectangle for additional information about the value.

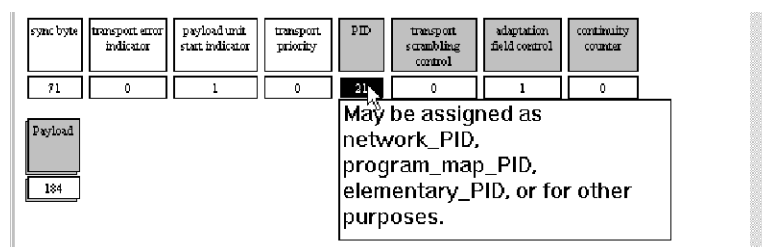

Double-click on a data field name to add a byte-by-byte hexadecimal view of the interpreted section, table, or packet.

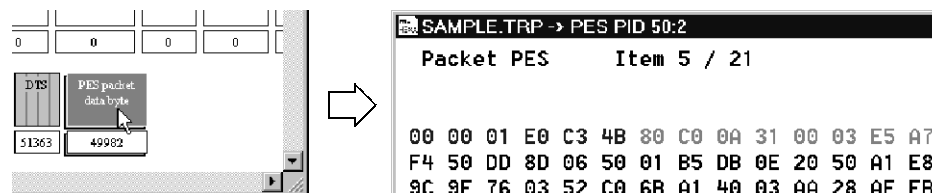

You can also display a hexadecimal view or binary view of any section or packet by selecting the Add view command from the Window menu or by clicking on the **Add view** command button in the upper toolbar.

Double-click on the descriptor field name in an SI table (NIT, SDT, EIT, or BAT) section for an ASCII decode of the descriptor information.

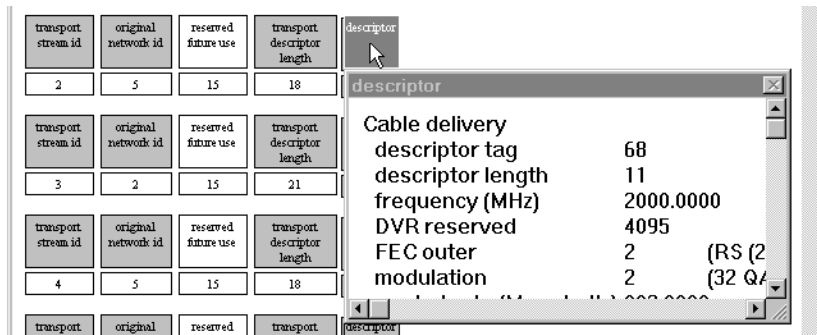

### Interpreted View Options

You can customize the appearance of the interpreted view through the Interpretation command on the Options menu. The Interpreted view options dialog box, with default selections, is shown below.

The Length and Position settings, explained on page 3-24, apply to all interpreted views. You can use the remaining controls to determine which fields appear in transport packet, PES packet, or (table) section interpreted views.

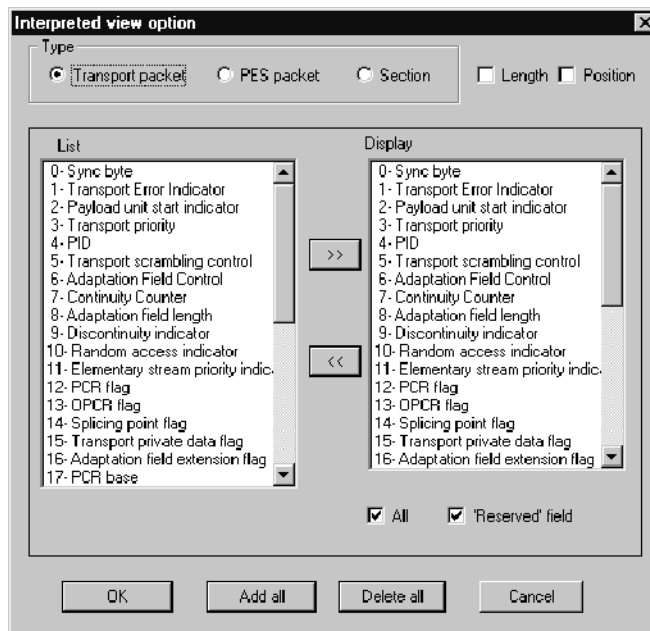

To configure the options, do the following:

1. Click the **option** button in the Type field to select the type of interpreted view you want to change.
2. The default display is All fields, including the Reserved field. To hide a field, select it in the Display list box and click the << button.



- To show just a few fields, click **Delete all**; this clears the display box, All check box, and 'Reserved' field check box. Then select a field name from the List dialog box and click the >> button. Repeat this until all the fields you want to display are listed in the Display box. If you also want to display the Reserved field, select that check box. Click **OK**. The changes take effect immediately.
- If you made changes to the displayed fields, **\*\*\*Warning, display option\*\*\*** appears at the top of the interpreted view window.



- To restore the interpreted view to the original configuration, select **Interpretation** from the Options menu, click the appropriate **Type** option button, click either **Add all** or the **All check** box; then click **OK**.

### Saving an Interpreted View

You can store a transport stream or PSI, DVB SI, ATSC PSIP, or ISDB-S/ARIB table.

## Hexadecimal and Binary Views

You can add a hexadecimal view of the current interpreted view item by double-clicking on a payload or data bytes name box. However, some items such as table sections do not have these fields. To create a hexadecimal or binary view for any interpreted view item, either click on the **Add view** command button (in the upper toolbar) or select the **Add view** command from the Window menu. A submenu, appropriate to the current item, appears as shown:

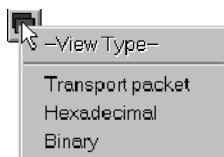

Select the top submenu command (Transport packet in the example) to add a new interpreted view; select Hexadecimal or Binary to view the bytes or bits that are the basis for the interpreted view.

### The Hexadecimal View

The hexadecimal view shows the contents of the current item on a byte-by-byte basis. The first few bytes appear in blue characters on the display to indicate that

they are required header information for the type of item. A transport packet has four required bytes; a PES packet has six. The blue, required bytes may be followed by several bytes shown in gray. The gray bytes are optional or variable header information. The remaining bytes, displayed with black characters, are the payload or data bytes.

When displaying a hexadecimal view of transport packets with a 204 byte length, the last 16 bytes are shown in red.

The hexadecimal view window shows the number of the displayed item, just like the interpreted view. When you use the command buttons to move among similar items in the stream, the hexadecimal view changes to display the contents of the current item.

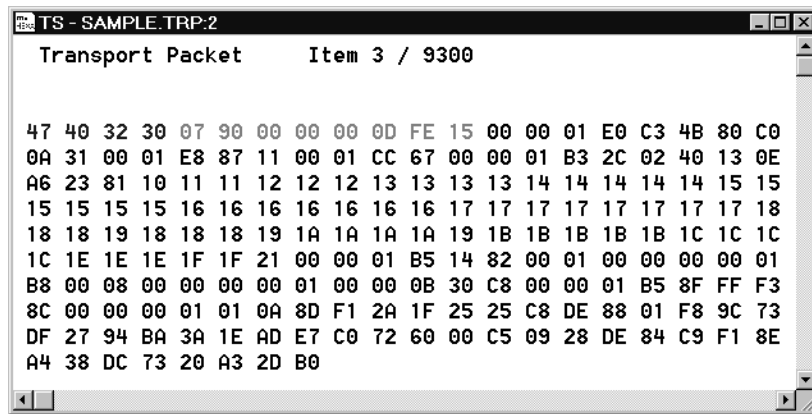

### The Binary View

The binary view displays the current item on a bit-by-bit basis. The same character color conventions used in the hexadecimal view apply to the binary view. The contents will also change when you use the command buttons to move among items in the stream.

When displaying a binary view of transport packets with a 204 byte length, the last 16 bytes are shown in red.

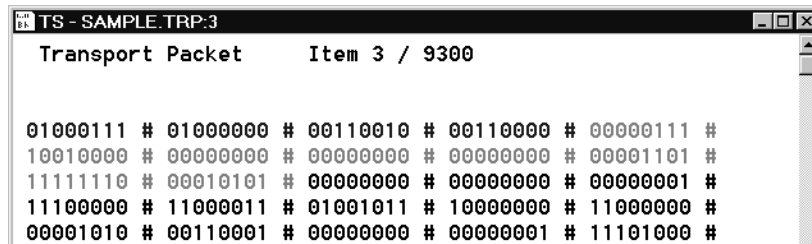

## Multiplex Analyses

The Multiplex Characteristics commands provide valuable information about the way programs are multiplexed in the MPEG-2 transport stream. To access these commands, select **Multiplex Characteristics** from the Analysis menu; then select one of the following entries: Rate, Multiplex Allocation, PID Map.

### Multiplex Rate

To calculate the multiplex rate of a transport stream, select the window that contains the hierarchic view and then either select **Rate** from the Multiplex Characteristics submenu or type **CTRL+R**. The Transport Stream Property dialog box appears, displaying the multiplex (mux) rate and the number of programs in the stream.



The analyzer calculates the multiplex rate from the first ten PCRs found in the transport stream. Because the sample is small and the precision of the number is high, there can be error in the calculation. To ensure maximum accuracy of analyses that use the multiplex rate to calculate results and detect errors, you can enter the actual multiplex rate (if you know it) in the dialog box.

For example, if the exact multiplex rate of a stream is 10 Mb/s instead of the reported 9,999,999 bits/s, enter 10000000 in the Mux Rate text box before clicking OK. This increases the accuracy of subsequent PCR, PTS/DTS, and Dynamic analyses, which use the multiplex rate in their calculations.

**Allocation** Select **Multiplex Allocation** from the Multiplex Characteristics submenu to see a pie chart of the transport stream. The chart shows the stream fraction occupied by packets of each unique PID.

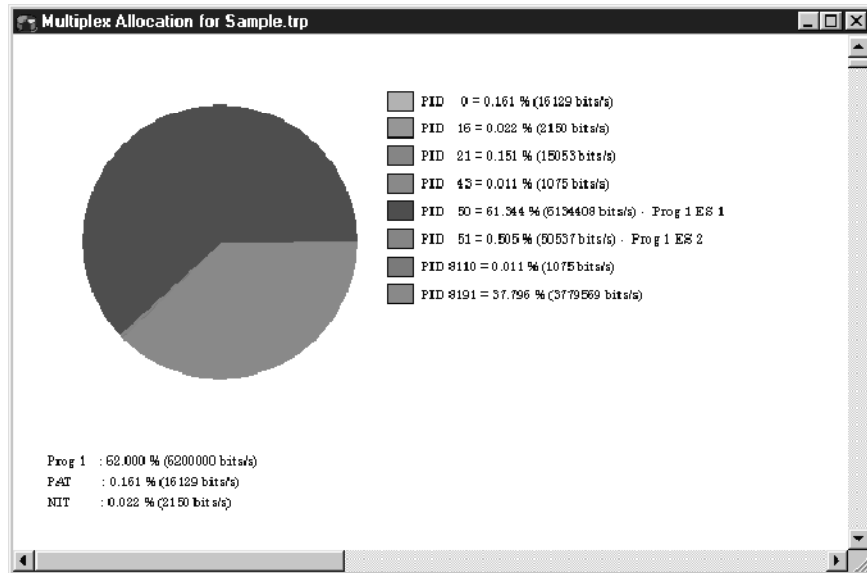

The analyzer calculates the percentages shown in the graph key by dividing the actual number of transport packets of a given PID by the total number of packets in the transport stream file.

All PIDs found in the transport stream are represented; those that are not referenced in a PAT or PMT will appear in the hierarchic view only after a consistency check (described under *Consistency Check* on page 3-34).

PID 8191 is reserved for stuffing bytes; it is not shown in the hierarchic view.

**PID Map** To open a PID map of transport stream file, select the hierarchic view and then select **PID Map** from the Multiplex Characteristics submenu. A window containing a PID map of the first 100 packets appears in the application window. Use either the Edit menu commands or the command buttons in the lower toolbar to display the PID maps of the other 100-packet portions of the stream.

The PID map lists the PID of every transport packet in the stream. In the map, each packet is represented by its PID, and each unique PID is color-coded according to the type of element it identifies. For example, the PIDs of packets that contain data for video elementary streams are displayed in light blue characters.

TS packets 1 to 100 - Colours according to PSI version number 1	PAT	PMT	NIT	CAT	SDT	EIT	BAT	RST	TDT	CMT	SI	Video	Audio	PCR	Stuffing	Private Data	Other
(0000001)	0000	0021	0050	8191	0050	0050	8191	0050	8191	0050	8191	0050	8191	0050	8191	0050	8191
(0000011)	0050	8191	0050	0050	8191	0050	8191	0050	0050	8191	0050	8191	0050	8191	0050	8191	0050
(0000021)	0050	8191	0050	0050	8191	0050	8191	0050	8191	0050	0050	8191	0050	8191	0050	8191	0050
(0000031)	0050	0050	8191	0050	8191	0050	8191	0050	0050	8191	0050	8191	0050	8191	0050	8191	0050
(0000041)	0050	0050	8191	0050	0050	8191	0050	8191	0050	8191	0050	8191	0050	8191	0050	8191	0050
(0000051)	8191	0050	8191	0050	0050	8191	0050	8191	0050	8191	0050	8191	0050	8191	0050	8191	0050
(0000061)	8191	0050	0050	8191	0050	8191	0050	8191	0050	0050	8191	0050	8191	0050	8191	0050	8191
(0000071)	8191	0050	0050	8191	0050	0050	8191	0050	8191	0050	8191	0050	8191	0050	8191	0050	8191
(0000081)	0050	8191	0050	8191	0050	0050	8191	0050	8191	0050	0050	8191	0050	8191	0050	8191	0050
(0000091)	0050	8191	0050	0050	8191	0050	8191	0050	8191	0050	8191	0050	8191	0050	8191	0050	8191

## Check CRC

Many MPEG-2 tables (such as the PAT, PMT, and SDT) have CRC (Cyclic Redundancy Code) fields. CRC field values are calculated from table data during encoding. The decoder performs an additional calculation based on the received data and compares that result to the field value to verify correctness.

The analyzer automatically calculates and compares the CRC of the first PAT section when opening a transport stream file. Use the following procedure to check all CRCs in a transport stream.

1. Select the stream PSI hierarchic view.
2. Select **Check CRC** from the Analysis menu.
3. During the analysis, the Message for... window opens to report errors, warnings, and analysis-specific information. To expand the messages, select the window and type \* on the numeric keypad. To learn more about the Message for... window, see page 3-72.

- If the message window identifies CRC errors, double-click on the associated *Packet* message entry to open an interpreted view of the section containing the error.

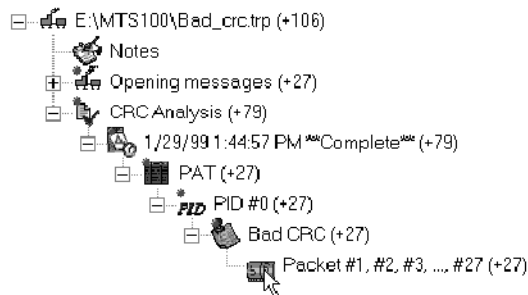

- Erroneous field values are displayed in red characters. Double-click on the bottom value rectangles to confirm the error.

Bad\_crc.trp -> PAT - Standard: MPEG-2

Program Association Section Item 1 - Position: 945 b

table id	section syntax indicator	zero	reserved	section length	transport stream id	reserved	version number	current next indicator	section number	last section number
0	1	0	3	17	49	3	0	1	0	0

program number	reserved	program.map PID
1	7	50
2	7	51

CRC

Bad CRC

## Syntactic Analysis

Use the following procedure to perform a Syntactic analysis:

1. To analyze all elements in the transport stream file, select the hierarchic view and select **Syntactic** in the Analysis menu. To analyze the syntax of a single stream element, open an interpreted view of the element (double-click on the icon in the hierarchic view) and select **Syntactic** from the Analysis menu.
2. During the analysis, the Message for... window opens to report errors, warnings, and analysis-specific information. To expand the messages, select the window and type \* on the numeric keypad. To learn more about the Message for... window, see page 3-72.
3. If the message window identifies Syntax errors, double-click on the associated *Packet* message entry to open an interpreted view of the section containing the error.

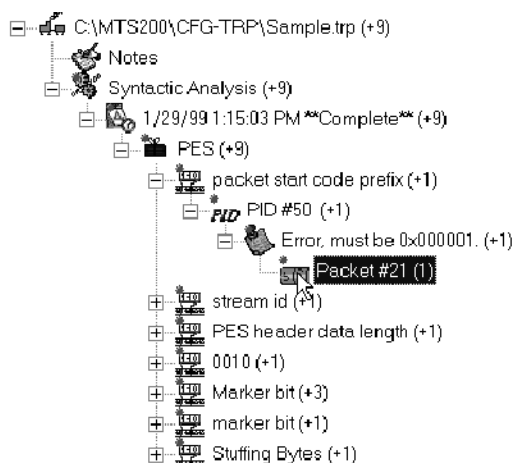

4. Erroneous field values are displayed in red characters. Double-click on the bottom value rectangles to confirm the error.

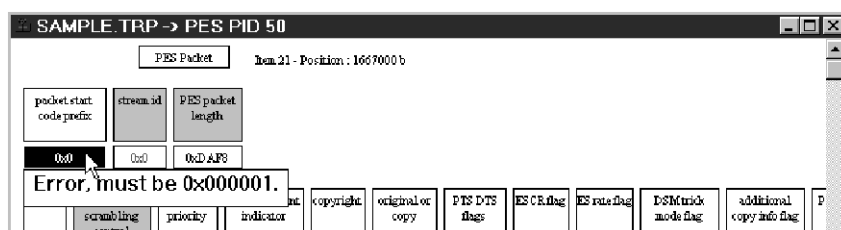

## Consistency Check

The Consistency check verifies the consistency of several table and stream items within the PSI (MPEG-2), SI (DVB), PSIP (ATSC) and ISDB-S/ARIB hierarchic views.

---

**NOTE.** *The analyzer performs a PSI consistency check on the first 3000 valid transport packets when you first open a transport stream file. Errors can easily occur in later packets; always conduct a manual consistency check to eliminate the possibility of consistency errors in the rest of the transport stream.*

---

### PSI Coherence

The PSI consistency check reviews the following items:

- Internal PSI table and PMT descriptor consistency
- PSI table and transport stream coherency:
  - Missing PAT and PMT PID references
  - Conformance of stream-types to standards
  - Missing PCRs in PCR\_PID referenced packets
  - Location of nonreferenced PID transport packets

### SI Coherence

The SI consistency check reviews the following items:

- Required transport stream SI tables: NIT actual, SDT actual, EIT actual (present/following), TDT
- Internal SI table coherence
- PSI and SI table:
  - Coherence of transport\_stream\_id between SDT actual and PAT
  - Coherence of transport\_stream\_id between NIT actual and PAT
  - Coherence of service\_id between SDT actual and PMT program\_number

Table 3-21 identifies the SI Consistency Check abbreviations used in the error message window; *n* denotes an integer value.



**Table 3-21: SI consistency error abbreviations**

Abbreviation	Meaning
<i>S n</i>	Section number <i>n</i> (software order)
<i>L n</i>	Loop number in section <i>n</i>
FDL	First descriptor loop
<i>D n</i>	Descriptor number <i>n</i> in the loop
<i>Nid n</i>	Network_id = <i>n</i>
<i>Tid n</i>	Table_id = <i>n</i>
<i>Tsid n</i>	Transport_stream_id = <i>n</i>
<i>Sid n</i>	Service_id = <i>n</i>
<i>Onid n</i>	Original_network_id = <i>n</i>
<i>Eid n</i>	Event_id = <i>n</i>
<i>Bid n</i>	Bouquet_id = <i>n</i>
<i>Pn n</i>	Program number <i>n</i>
<i>Sn n</i>	Section number <i>n</i>
<i>Vn n</i>	Version number <i>n</i>

**PSIP Coherence**

The PSIP consistency check reviews the following items:

- Required transport stream PSIP tables: MGT, TVCT, CVCT, EIT, ETT, RRT, STT
- Internal PSIP table coherence
- PSI and PSIP table:
  - Coherence of transport\_stream\_id between the TVCT,/CVCT and PAT
  - Coherence of program\_number between the TVCT/CVCT and PAT
  - Coherence of channel definition service location descriptor (TVCT terrestrial or CVCT cable) and elementary stream description of the corresponding program in the PMT

**Table 3-22: PSIP consistency error abbreviations**

Abbreviation	Meaning
<i>S n</i>	Section number <i>n</i> (software order)
<i>L n</i>	Loop number in section <i>n</i>
GDL	General descriptor loop
<i>D n</i>	Descriptor number <i>n</i> in the loop
<i>Tid n</i>	Table_id = <i>n</i>

**Table 3-22: PSIP consistency error abbreviations (Cont.)**

Abbreviation	Meaning
TidExt <i>n</i>	Table_id_extension = <i>n</i>
Tsid <i>n</i>	Transport_stream_id = <i>n</i>
Sid <i>n</i>	Source_id = <i>n</i>
Eid <i>n</i>	Event_id = <i>n</i>
Rr <i>n</i>	Rating_region = <i>n</i>
Pn <i>n</i>	Program number <i>n</i>
Sn <i>n</i>	Section number <i>n</i>
Vn <i>n</i>	Version number <i>n</i>

**Perform Manual Check**

Use the following procedure to perform a manual consistency check:

1. Select **MPEG-2, DVB, ATSC PSIP, or ISDB-S/ARIB** from the Options menu to include PSI, SI, or PSIP coherence in the search.
2. Select the hierarchic view of the stream you want to check.
3. Select **Consistency Check** from the Analysis menu.
4. During the analysis, the Message for... window opens to report errors, warnings, and analysis-specific information. To expand the messages, select the window and type \* on the numeric keypad. To learn more about the Message for... window, see page 3-72.

---

**NOTE.** The windows message unknown PID appears if a selected stream contains tables in a standard not selected in the Options menu.

---

**Perform Automatic Check**

With **DVB, ATSC or ISDB-S/ARIB** selected in the Options menu, the analyzer performs PSI and SI or PSI and PSIP or PSI, SI and ISDB consistency checks sequentially.

Use the following procedure to perform an automatic consistency check:

1. Select **Automatic analysis** from the Options menu. The Options for automatic analysis dialog box appears.
2. Select the **Consistency** check box and clear all others; then click **OK**.
3. Select the PSI/SI/PSIP hierarchic view of the stream you want to check.
4. Select **Automatic** from the Analysis menu.

- During the analysis, the Message for... window opens to report errors, warnings, and analysis-specific information. To expand the messages, select the window and type \* on the numeric keypad. To learn more about the Message for... window, see page 3-72. For additional information on automatic analysis or terminating the process, see page 3-54.

## PSI/SI/ISDB-S/PSIP Rate Analysis

Implement the following steps to perform a PSI/SI (DVB) PSI/PSIP (ATSC) PSI/SI/ISDB rate analysis on a transport stream:

- Select the hierarchic view; then select the **PSI Rate**, **PSI/SI Rate**, **PSI/SI/ISDB** or **PSI/PSIP Rate** command in the Analysis menu (the selection available depends on which mode you opened the transport stream file in).
- The analyzer opens a window similar to the one shown below that contains tabulated information about the various tables (PAT, PMT, NIT, SDT) in the transport stream and the frequency of their insertion into the stream.

	P. in bytes	P. in sec.	Table length	Rate	Occurrences	Min. time
PAT	120548	0.0964	20	1659	15	0.0501
PMT prog 1	124991	0.1000	26	2080	14	0.0998

P. in bytes : maximum of sub tables period average in bytes  
 P. in sec. : maximum of sub tables period average in seconds  
 Table length : average of sub tables size in bytes  
 Rate : average of sub tables rate in bits/second  
 Occurrences : average of sub tables occurrence  
 Min. time : minimum time in second between two sections with the same 'table\_id' 'table\_id\_ext'

- Table 3-23 explains the columns in the PSI/SI/PSIP rate table. The rate table refers to each table occurrence as a “subtable.”

**Table 3-23: Information in the PSI/SI/PSIP rate table**

Column	Reports
P. in bytes	The average number of bytes from the start of one table occurrence in the transport stream to the start of the next occurrence
P. in sec.	The average time (period, in seconds) between consecutive table occurrences; $(P. \text{ in bytes}) * (8 \text{ bits per byte}) / (\text{multiplex rate})$ . The analysis is compared to the MPEG-2 DVB/ATSC/ISDB-S/ARIB standard. A red display indicates an over-limit value.
Table length	Table size in bytes

**Table 3-23: Information in the PSI/SI/PSIP rate table (Cont.)**

Column	Reports
Rate	The average subtable bits per second of transport stream (the table length in bits divided by the average period)
Occurrences	The number of times the table occurs in the transport stream file
Min time	The shortest time (in seconds) between consecutive table occurrences. The analysis is compared to the MPEG-2 DVB/ATSC/ISDB-S/ARIB standard. A red display indicates an over-limit value.

Keep the following in mind when interpreting the PSI/SI rate table:

- The times listed depend on the analyzer's calculation of the multiplex rate. It is good practice to check the multiplex rate before conducting a PSI/SI/PSIP rate analysis and to correct the result if necessary. Refer to *Multiplex Rate*, on page 3-29, for more information.
- The PMT program numbers are not readily apparent from the hierarchical view. To discover the number of the program mapped by a particular PMT, double-click on the **PMT** icon. The program number is listed in the title of the interpreted view window. Program numbers are also listed in the interpreted view of the PAT.

## Timing Analyses

The MPEG-2 DVB/ATSC/ISDB-S/ARIB System Analyzer conducts two types of timing analysis: PCR (program reference clock) and PTS/DTS (presentation/decode time stamps). PCR clocks are encoded in transport stream packets and pertain to a given MPEG-2 program. The PTS/DTS are encoded into PES packets and pertain to individual elementary streams only.

### PCR Analysis

PCR analysis provides the following capabilities:

- View a graphic diagram of the PCR clocks of each program in the stream.
- Access detailed information about each PCR clock.
- Search for clock errors of a single program or all programs in the transport stream.

**Viewing a PCR graphic diagram.** To see a graphic diagram of the PCRs in a specific program, right-click on the **PMT** or **TS (with PCR)** icon to open the shortcut menu. Hold the button down and highlight the PCR Analysis command; then release the button to begin the analysis.



You can also begin a PCR analysis by selecting **PCR** from the Analysis menu. A dialog box will appear. Enter the number of the program you want to analyze and click **OK**.

The analyzer opens a PCR graphic view window. Typically, the initial view displays the first ten clocks found in the transport packets of the selected program. Each clock face icon represents one PCR clock. The arrow extending down from the clock icon to the time line is normally black; when the analysis detects a clock timing error, the line turns red.

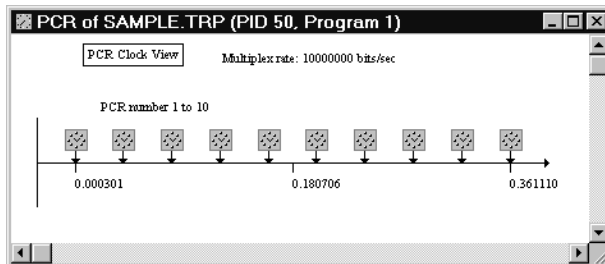

Use either the commands in the Edit menu or the command buttons on the lower toolbar to view the remaining clocks (of the selected program) in the transport stream.

**Listing PCR values.** Double-click on a clock icon to list detailed information about the clock.

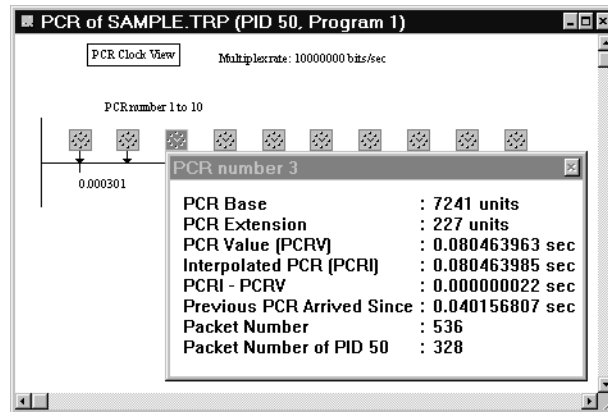

This information includes the following:

- *Interpolated PCR (PCRI):* The analyzer calculates interpolated PCR (PCRI) from the previous PCR value, the number of intervening bits, and the multiplex rate. If either the previous PCR or the multiplex rate is incorrect, the PCRI is also invalid. An invalid PCRI can cause a false PCRI-PCRv error.

If a PCR analysis results in numerous PCRI-PCRv errors, check the multiplex rate as described on page 3–29. In the case of an isolated PCRI-PCRv error, always check the previous PCR for accuracy.

- *Previous PCR Arrived Since:* Previous PCR Arrived Since is the time elapsed since the previous PCR of the same program. Any value over 0.1 second is an error and is displayed in red characters.
- *Packet Number:* The packet number identifies the transport packet that contains the PCR. To display an interpreted view of the packet, double-click on the TS (engine and tender) icon in the hierarchic view to open an interpreted view of the first transport packet. Then use the Edit menu or lower toolbar buttons to go to the packet that has the same item number as the PCR packet number.
- *Packet Number of PID n:* Packet Number of PID *n* identifies the packet that contains the PCR relative to all packets that have the same program ID. To display an interpreted view of the packet, double-click on the PID *n* PCR (freight car with clock) icon to open an interpreted view of the PID *n* packets, and then go to the packet with the same item number.

To list the values for all PCRs shown in the graphic view window, either select **Add view** from the Window menu or click on the add view command button in the upper toolbar. Then select **PCR Values** from the View Type submenu.

**Searching for PCR errors.** As mentioned earlier, the analyzer reports PCR errors with red arrows in the graphic view. Erroneous information also appears in red characters on the PCR value lists.

One way to search for PCR errors is to open a PCR graphic view and click the Next Error command button on the lower toolbar.

A good way to search for all PCR errors in an entire transport stream file is to use Automatic analysis. Automatic analysis is explained in detail beginning on page 3-54.

Use the following procedure to search for PCR errors using Automatic analysis:

1. Select **Automatic analysis** from the Options menu. The Options for automatic analysis dialog box appears.
2. Select the **PCR clocks** check box and clear all others; then click **OK**.
3. Select the PSI hierarchic view of the stream you want to check for PCR errors.
4. Select **Automatic** from the Analysis menu.
5. During the analysis, the Message for... window opens to report errors, warnings, and analysis-specific information. To expand the messages, select the window and type \* on the numeric keypad. To learn more about the Message for... window, see page 3-72.
6. If the message window identifies PCR errors, double-click on the packet error entry to create a PCR graphic view containing the erroneous clock. Double-click on the clock icon(s) to open a window that lists the PCR values.

### **PTS/DTS Analysis**

PTS/DTS analysis extracts the presentation and decode time stamps from PES packets encoded in the transport stream and shows those time stamps in a graphical format. The PTS/DTS timing diagram, like the PCR clock diagram, provides access to numerical data about the time stamps. It also offers information about the associated MPEG-2 access units.

PTS/DTS analysis enables the viewing the “vital statistics” (numerical data) of various timing objects and searching for PTS/DTS errors in one elementary stream or all elementary streams in the file.

**Viewing a PTS/DTS timing diagram.**

1. Right-click on the **PES** icon associated with the stream you want to analyze. Hold the mouse button down and highlight **PTS/DTS** on the shortcut menu.

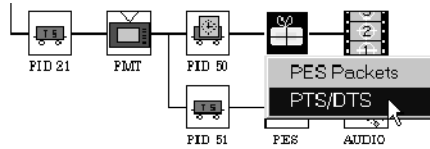

2. Release the button. A PTS/DTS timing diagram window appears, showing the first four PTS/DTS events and the closest PCRs. Table 3-24 explains the icons used and lists the information you can display by double-clicking on each icon.

**NOTE.** You can also begin PTS/DTS analysis by choosing *PTS/DTS* from the *Analysis* menu. A dialog box will appear. Enter the numbers of the program and stream you want to analyze and then click **OK**.

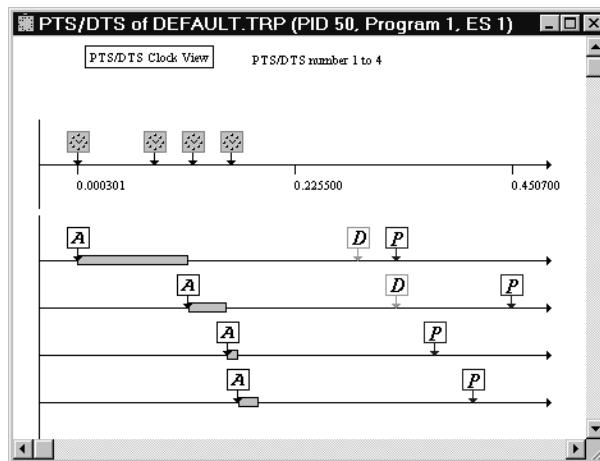





**Table 3-24: PTS/DTS graphic view icons**

Icon	Represents	Double-click for
	PCR (program clock reference)	Time value of the PCR and location of the packet within the transport stream (TS packet number)
	Arrival time of the PTS/DTS	Arrival time value, time since the previous PTS/DTS arrived, and location of the packet (PES packet number) within the elementary stream



**Table 3-24: PTS/DTS graphic view icons (Cont.)**

Icon	Represents	Double-click for
	DTS (decode time stamp)	Time value of the DTS and location of the packet within the elementary stream (PES packet number)
	PTS (presentation time stamp)	Time value of the PTS and location of the packet within the elementary stream (PES packet number)
	AU (access unit)	Begin time End time Size in bytes Type of frame (intra, predicted, or bidirection) Reference time
	Beginning of a GOP	Not applicable

The arrows leading down from the A, D, and P icons to the time line are normally black, but turn to red when an error is associated with the object. Red characters also highlight errors in the PTS/DTS value windows that appear when you double-click on an icon.

The example timing diagram illustrates several features of a correctly encoded MPEG-2 video stream:

- Access units arrive one after another, as you can see from the left (“early”) side of the diagram.
  - The order of access unit decoding and presentation is visible in the right (later) portion of the diagram.
  - Intra (I) and predicted (P) pictures must be decoded before presentation and therefore have both DTS and PTS. Bidirection (B) frames are decoded and presented at the same time and therefore have only presentation time stamps.
  - B frames use information in an associated P frame; the P frame must be decoded before the B frame(s), but is presented after. In the example, then, the order of frame decoding is IPBB, but the order of presentation is IBBP.
3. Use the Edit menu commands, or the command buttons on the lower toolbar, to view diagrams of other time stamps and to search for time stamp errors in the same elementary stream.
  4. To view the data for all time stamps and access units at once, select **Add view** from the Window menu or click on the Add view command button. Select **PTS/DTS values** from the View type submenu. The resulting window lists information about the displayed time stamps in the left column and information about the access units on the right. The number of access units in the display appears after *Nb Access Unit*: at the top of the window.

Incorrect values (such as equal PTS and DTS values, or an arrived value that is later than either the PTS or DTS) are displayed in red characters.

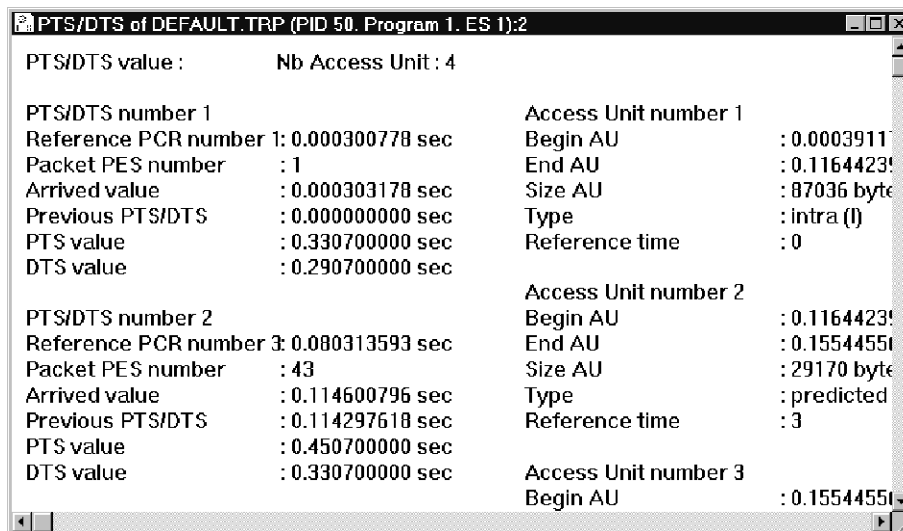

**Searching for PTS/DTS errors.** As mentioned earlier, one way to search for PTS/DTS errors is to open a graphic view and look for red arrows leading from A, P, and D icons to the time line. If no errors are present, click on the **Next error** command button (on the lower toolbar) to search for errors later in the elementary stream.

A good way to check the entire transport stream file for PTS/DTS errors is to use Automatic analysis. Automatic analysis is explained in detail beginning on page 3-54.

Use the following procedure to search for PTS/DTS errors using Automatic analysis:

1. Select **Automatic analysis** from the Options menu. The Options for automatic analysis dialog box appears.
2. Select the **PTS/DTS stamps** check box and clear all others; then click **OK**.
3. Select the PSI hierarchic view of the stream you want to check for errors.
4. Select **Automatic** from the Analysis menu.
5. During the analysis, the Message for... window opens to report errors, warnings, and analysis-specific information. To expand the messages, select the window and type \* on the numeric keypad. To learn more about the Message for... window, see page 3-72.

6. If the message window identifies PTS/DTS errors, double-click on the packet error entry to create a PTS/DTS graphic view containing the erroneous time stamp.
7. A red arrow leading from an icon to the time line indicates an error. Double-click on the icon that represents the incorrect time stamp to create a value window for the stamp.

## Semantic Analysis

Use the following procedure to perform a Semantic analysis on an MPEG-2 transport stream:

1. Select the PSI hierarchic view of the stream you want to analyze.
2. Select **Semantic** from the Analysis menu.
3. During the analysis, the Message for... window opens to report errors, warnings, and analysis-specific information. To expand the messages, select the window and type \* on the numeric keypad. To learn more about the Message for... window, see page 3-72.
4. If the message window identifies semantic errors, double-click on the associated *packet* message entry to open an interpreted view of the section containing the error.

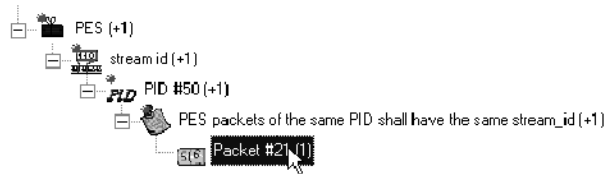

5. For additional information about an erroneous field, double-click on the name of the field containing the error. The analyzer does not identify semantic errors with red characters or special symbols in this interpreted view.

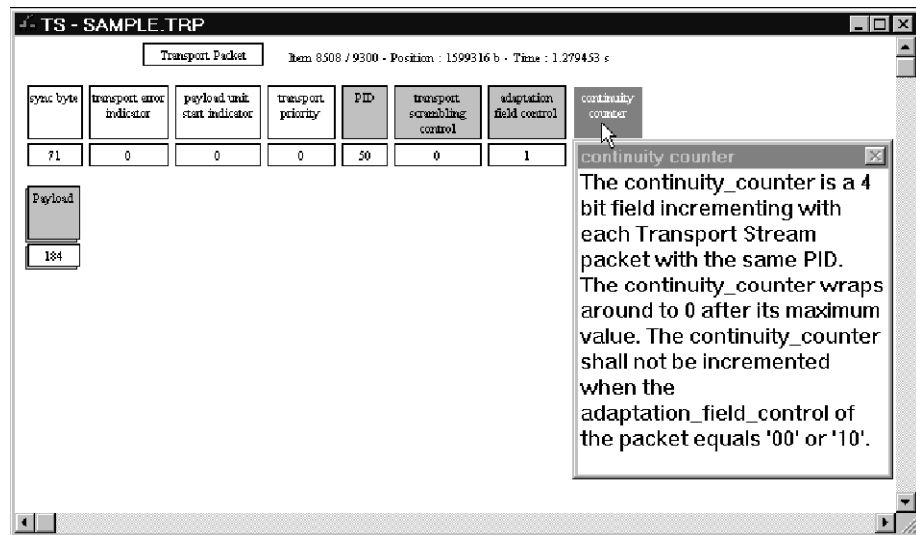

## Mega-frame (MIP) Analysis

This analysis checks the coherence of mega-frame initialization packets, a concept described by the DVB-T standard. A MIP is a special transport packet with its own syntax, which is always located in PID 0x15.

Use the following procedure to perform a Mega-frame analysis:

1. Select the PSI hierarchic view of the DVB stream you want to analyze.
2. Select **Mega-frame (MIP)** from the Analysis menu.
3. During the analysis, the Message for... window opens to report errors, warnings, and analysis-specific information. To expand the messages, select the window and type \* on the numeric keypad. To learn more about the Message for... window, see page 3-72.
4. If the message window identifies mega-frame errors, double-click on the associated *packet* message entry to open an interpreted view of the section containing the error.
5. Erroneous field values are displayed in red characters. Double-click on the value rectangles to confirm the error.

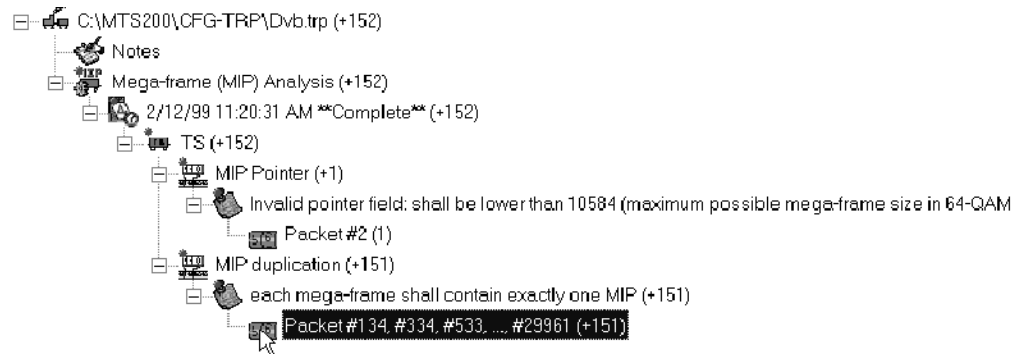

## Dynamic Analyses

The analyzer performs the following types of dynamic analyses:

- T-STD (transport stream target decoder), which checks the selected program against the decoder model defined in the MPEG-2 standard.
- LTW (legal time window) offset, which checks the validity of the optional LTW offset and piecewise rate adaptation fields of the transport packets.
- Smoothing buffer simulation.

---

**NOTE.** *The MPEG-2 DVB/ATSC/ISDB-S/ARIB System Analyzer dynamic analysis algorithm uses the “Leak method” to transfer video elementary stream data from the main buffer, MBn, to the elementary stream buffer, EBn. Buffer overflow can occur when analyzing streams (such as those created with the MPEG Test System Multiplexer application) that require “VBV delay method” data transfer.*

*Refer to ISO/IEC 13818-1 for additional information about Leak method and VBV delay method buffering.*

---

### Visual Mode

T-STD and LTW analyses provide a visual mode you can switch on and off. Visual mode graphically represents the contents of the various decoder buffers, shows the progress of the analysis, and provides a method to abort the process. With visual mode active, the analysis time increases however. You must switch visual mode on or off before you begin a T-STD or LTW analysis. In the Options menu, click **Visual TSTD and LTW** to make the selection.

### T-STD Analysis

The MPEG-2 DVB/ATSC/ISDB-S/ARIB System Analyzer can perform T-STD analysis on a selected program in the current transport stream or on all programs in the stream.

**Analyzing a Selected Program.** There are two ways to start a manual analysis of a single program:

1. Click on the appropriate PMT icon with the right mouse button; then select **T-STD Analysis** from the shortcut menu.

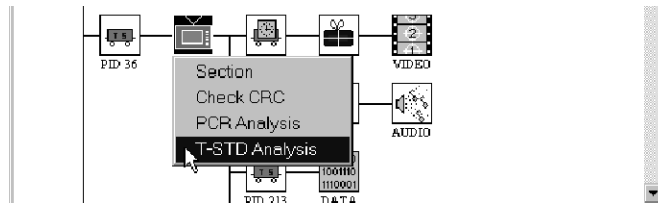

The analyzer checks all video and audio streams in the program, and, if visual mode is selected, creates a T-STD Buffering Simulation window as shown on page 3-49. The graphic simulation shows buffer use of the first video and the audio streams listed in the PMT.

2. With the hierarchic view selected, select **Dynamic** from the Analysis menu; then select **T-STD** from the submenu. The TSDT Analysis dialog box appears.

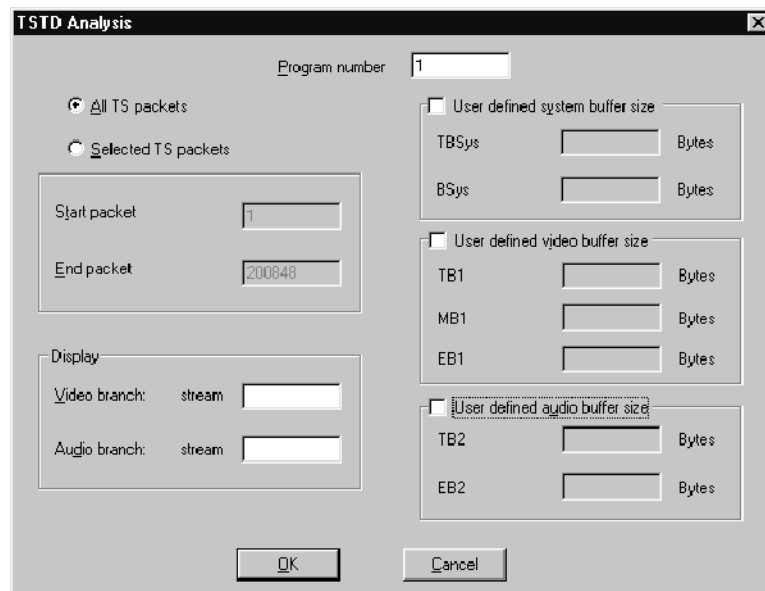

Enter the following information in the check boxes:

- Enter the program you want to analyze. The program number in this dialog box refers to the order that the particular program is listed in the hierarchic view.
- To limit the portion of the stream to be analyzed, click the **Selected TS packets** option button and enter the starting and ending packet numbers.
- The analyzer checks all elementary streams in the selected program, but by default, shows a graphic presentation of only the first video and the first audio elementary streams listed in PMT and hierarchic view. If you want to see how a different stream uses the buffers, enter the stream number according to the order the stream is listed among the video and audio streams in the program. For example, to analyze the stream listed fourth under the program listed third in the hierarchic view, enter **3** in the Program number box and **4** in the Stream number box.
- You can define the video, audio, and system, buffer sizes. If you choose to do so, complete all entries.

When you have entered all appropriate information, click **OK**. The T-STD Buffering Simulation... window appears (if visual mode is selected).

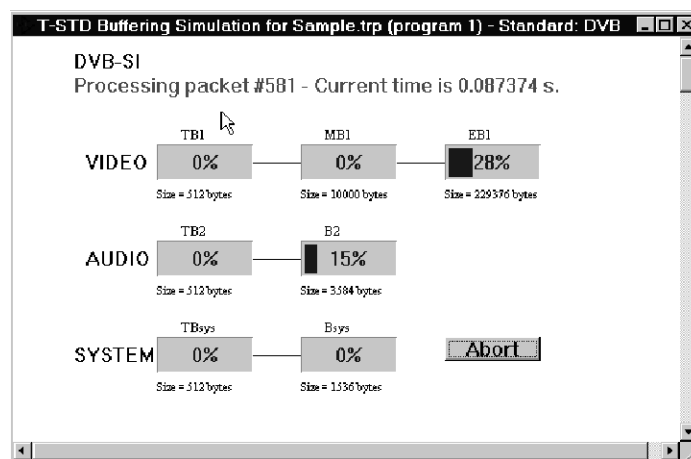

The Buffering Simulation window has the following features:

- A counter that shows the current packet number.
- A display of the current PCR time.

- Dynamic bar graphs of the three video branch buffers. If the program has no video elementary stream, **\*\*\*unused\*\*\*** appears under each bar (instead of size information). The buffer bars change colors to indicate usage:

Blue = normal  
 Yellow = filling up  
 Orange = close to overflow  
 Red = buffer full.

- Dynamic bar graphs of the two audio branch buffers that follow the same usage and color conventions as the video branch buffers.
- Dynamic bar graphs of the two system buffers that follow the same usage and color conventions as the video branch buffers.
- An Abort button that permits you to pause or end the simulation before the end of the stream.

At the end of the analysis, all activity in the T-STD Buffer Simulation window stops; if you are not using visual mode, the analyzer presents an End of simulation dialog box.

Close the buffering simulation window to read the test results in the Message window.

The Message for... window reports errors, warnings, and analysis-specific information. To expand the messages, select the window and type \* on the numeric keypad. To learn more about the Message for... window, see page 3-72.

If the analyzer detects buffer underflow or overflow, errors are identified by program number and packet ID in the message window. A new entry is added when packet numbers are not consecutive between the previous error and the current error.

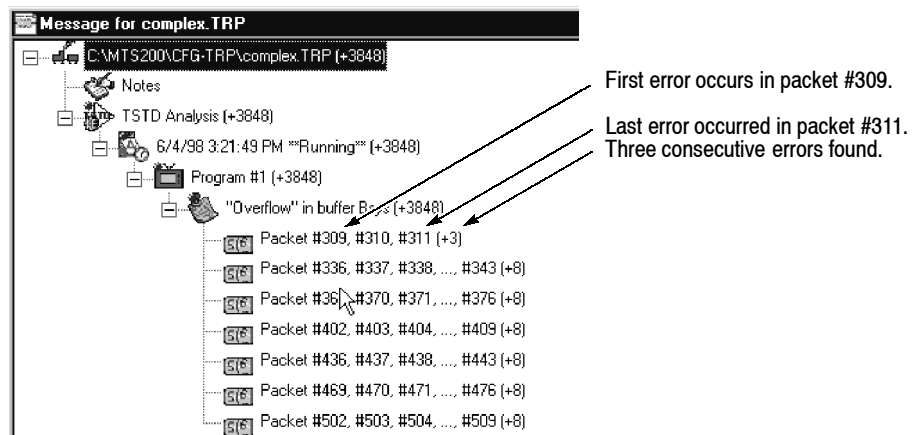



Double-click on packet message entries to open an interpreted view of items containing errors.

**Analyzing all Programs in a Stream.** You can use Automatic analysis to check an entire stream at once for T-STD buffering errors.

1. Select **Automatic analysis** from the Options menu. The Options for automatic analysis dialog box appears.
2. Select the **Dynamic** check box and clear all others; then click **OK**.
3. Select the PSI hierarchic view of the stream you want to check for T-STD errors.
4. Select **Automatic** from the Analysis menu. A Buffering Simulation window will not appear, even if Visual TSTD and LTW is selected in the Options menu.

---

**NOTE.** *A T-STD automatic analysis of an entire stream can take several minutes depending on the file sizes.*

---

During the analyses, the Message for... window opens to report errors, warnings, and information about the analysis. To view messages, select the window and type \* on the numeric keypad. To learn more about the Message for... window, see page 3-72. For additional information on automatic analysis or terminating the process, see page 3-54.

If the analyzer detects buffer underflow or overflow, errors are identified by program number and packet ID in the message window. A new entry is added when packet numbers are not consecutive between the previous error and the current error.

5. Double-click on packet message entries to open an interpreted view of items containing errors.

**T-STD Notes.** Consider the following when reviewing T-STD analysis errors:

- Overflow at the beginning of the simulation may not indicate encoder problems, because the analyzer must wait for the first DTS in the stream before emptying the EB and B buffers. Buffer overflow after the first DTS, however, indicates improper encoding.
- T-STD errors can arise from several different sources, including PCR errors, PTS/DTS errors, and multiplexing errors. PCR analysis, PTS/DTS analysis, and analysis of the Multiplex Characteristics may help locate the problem.

- Remember that although the error message window lists the last packet that results in buffer overflow or underflow, the cause of the error is probably earlier in the stream.

## LTW Analysis

LTW analysis checks the validity of the optional LTW offset and piecewise rate adaptation fields of the transport packets that contain the selected stream. The analyzer does this by remultiplexing the packets to place each at the end of its legal time window; it then performs a standard T-STD analysis on the resulting transport stream.

To perform an LTW analysis, do the following:

- Select **Dynamic** from the Analysis menu; then select **LTW** from the submenu. The LTW Analysis dialog box appears.

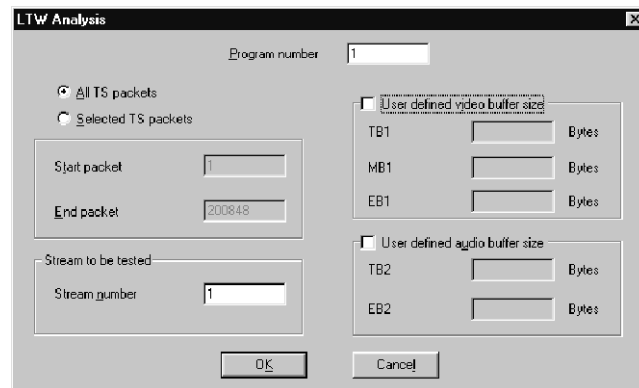

- Enter the program you want to analyze. The program number in this dialog box refers to the order that the particular program is listed in the hierarchic view.
- To limit the portion of the stream to be analyzed, click the **Selected TS packets** option button and enter the starting and ending packet numbers.
 

The analyzer checks all elementary streams in the selected program, and by default, shows a graphic presentation of only the first video and the first audio elementary streams listed in PMT and hierarchic view.
- If you want to see how a different stream uses the buffers, enter the stream number according to the order the stream is listed among the video and audio streams in the program. For example, to analyze the stream listed fourth under the program listed third in the hierarchic view, enter **3** in the Program number box and **4** in the Stream number box.
- You can define the video and audio buffer sizes. If you choose to do so, complete all entries.

6. When you have entered all appropriate information, click **OK**.

If you selected Visual TSTD and LTW from the Options menu, a graphic window similar to the T-STD Buffering Simulation window appears (see page 3-49). However, because only one stream is analyzed at a time, the video or audio branch buffers (depending on the type of stream) are used.

---

**NOTE.** *If the packets of the selected stream do not contain LTW offset fields, the analyzer conducts a normal T-STD analysis of the stream.*

---

At the end of the analysis, all activity in the LTW Buffer Simulation window stops; if you are not using visual mode, the analyzer presents an End of simulation dialog box. Close the buffering simulation window to read the test results in the Message window.

The Message for... window reports errors, warnings, and analysis-specific information. To expand the message, select the window and type \* on the numeric keypad. To learn more about the Message for... window, see page 3-72.

If the analyzer detects buffer underflow or overflow, errors are identified by program number and packet ID in the message window. A new entry is added when packet numbers are not consecutive between the previous error and the current error.

7. Double-click on packet message entries to open an interpreted view of items containing errors.

### **Smoothing Buffer Simulation**

This analysis simulates a smoothing buffer using the values in the smoothing buffer descriptor field that is optional in PMTs.

To begin smoothing buffer analysis, open the hierarchic view and select **Dynamic** from the Analysis menu; then select **Smoothing Buffer** from the Dynamic submenu. If the analyzer detects any overflow or underflow errors, it creates a Message for... window and lists the errors. There is no graphic representation of smoothing buffer analysis.

## **Automatic Analysis**

Using Automatic analysis, you can conduct a sequence of analyses on an entire transport stream file. This provides a convenient way to screen a newly captured transport stream for a wide variety of errors. As explained in the discussions of PCR analysis (page 3-41), PTS/DTS analysis (page 3-44), and T-STD dynamic analysis (page 3-51), Automatic analysis is helpful in searching for errors in the entire transport stream/multiplex, as opposed to the narrow searches of a single program or stream conducted by initiating the same single analysis.

Automatic analysis takes several seconds to many minutes to perform, depending on the size and complexity of the file, speed of your computer, and the number and type of analyses selected through this dialog box.

Dynamic analysis takes longer to run than all other tests combined. Be sure you want to check all elementary streams in the transport stream multiplex for compatibility with standard decoder buffers before selecting the Dynamic check box. You can select all analyses but Dynamic for the first look at a transport stream and later go back and select only Dynamic when you are ready to confirm decoder compatibility.

To initiate an Automatic analysis, perform the following steps:

1. Select **Automatic analysis** from the Options menu. The following dialog box appears.

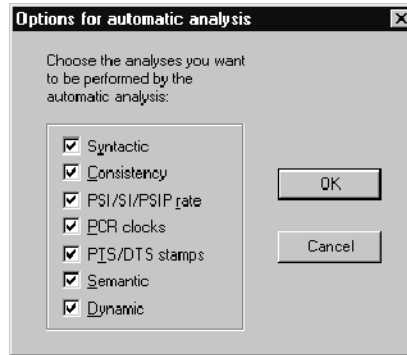

2. Clear the check boxes of the analyses you do not want to perform.

---

**NOTE.** The MPEG-2 DVB/ATSC/ISDB-S/ARIB System Analyzer can conduct three kinds of Dynamic analysis: T-STD (transport stream target decoder), LTW (legal time window), and Smoothing Buffer. Automatic analysis includes only T-STD analysis; the remaining dynamic analyses must be performed manually. Refer to Dynamic Analyses, on page 3-47, for more information.

---

3. Click **OK** to confirm the selections and close the dialog box.
4. Select **Automatic** from the Analysis menu.

The Automatic analysis for... window appears momentarily before being covered by the Message for... window. The Automatic analysis for... window lists the progress of each test. As the analysis proceeds, cells in the Status column change from blank to Running to Completed. As each test is completed, either OK or Errors appears in the corresponding Result cell. If you want to view the Automatic analysis for... window during the analysis, reposition the message window to the side.

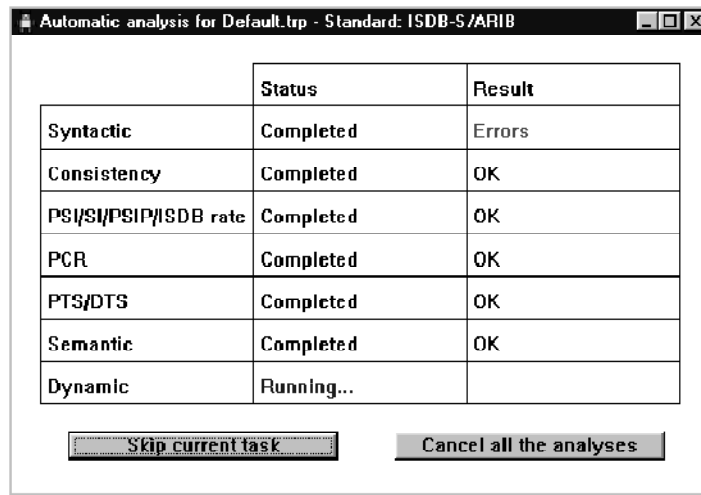

**NOTE.** To end the Automatic analysis at any time, click **Cancel all the analyses** in the bottom-right corner of the Automatic analysis for... window. To abort the current “Running” analysis, click **Skip current task**.

5. During the analysis the Message for... window reports errors, warnings, and information specific to each test. To expand the messages, select the window and type \* on the numeric keypad.

To learn more about the error messages associated with each test, refer to the individual analyses sections. To learn more about the Message for... window, refer to *Message Window* on page 3-72.

## Filters

The MPEG-2 DVB/ATSC/ISDB-S/ARIB System Analyzer filtering capability allows you to find and view transport stream packets, PES packets, and PSI/SI/PSIP/ISDB-S/ARIB table sections that meet one or more criteria of your choosing. You can create filters to find and display the following stream objects for example:

- Transport packets that contain the first bytes of all PES packets of a given elementary stream (as indicated by the presence in the payload of hexadecimal string 00 00 01).
- Transport packets of a given PID in which the payload unit start indicator is set to one.
- PSI/SI/PSIP/ISDB (table) sections of a given PID that contain a descriptor tag with a value of 64.

- PES packets of a given PID that lack both PTS and DTS (PTS/DTS flag set to zero).

When you define a filter, you specify the output level (transport packets, table sections, or PES packets) and, if necessary, the PID. You can use from one to four filtering criteria per filter. When applied, the filter looks for packets or sections that meet all criteria and opens an interpreted view of the first item found.

Once a filter is created, you can save it to a \*.flt file for use in later analyzer sessions; you can also edit existing filters and save them under a new name.

You can save an unlimited number of filters and have up to five open at any time, ready to apply to the current transport stream.

### Creating a Filter

Use the following steps to create a filter.

1. Select **Filters** from the Selection menu; then select **New** from the submenu. The first Filters - Criterion dialog box appears.

2. Enter the appropriate information and select options as necessary. Completion of the first Filters - Criterion definition box is mandatory.
  - The Filter name can be up to eight characters long. By default, the name you enter is proposed as the file name when you save the filter.

- The Comment field can contain up to 255 characters. Enter a description that will help you identify the filter and its function when you later open, edit, or apply it.
- Output level is the type of object you want to find. The filter result is an interpreted view representing the packets or sections that meet the filter (search) criteria.
- Enter the PID of the packets you want to filter; you can select All PIDs only if you have specified Transport Packet output.

If you select TS Packets which PID =, your selections in this dialog box should fill in the blanks in the statement “I want to find the [blank\_1] items that are identified with [blank\_2]...” where blank\_1 is the output level and blank\_2 is either “any PID” or PID *n*.

If the Output level is PSI/SI/PSIP/ISDB-S/ARIB Section or PES packet, you cannot perform a search on All PIDs; you must enter a PID number.

3. Click **Cancel** to close the dialog box and suspend filter definition, click **End** to terminate filter definition, or click **Next** to open the second Filters - Criterion dialog box.

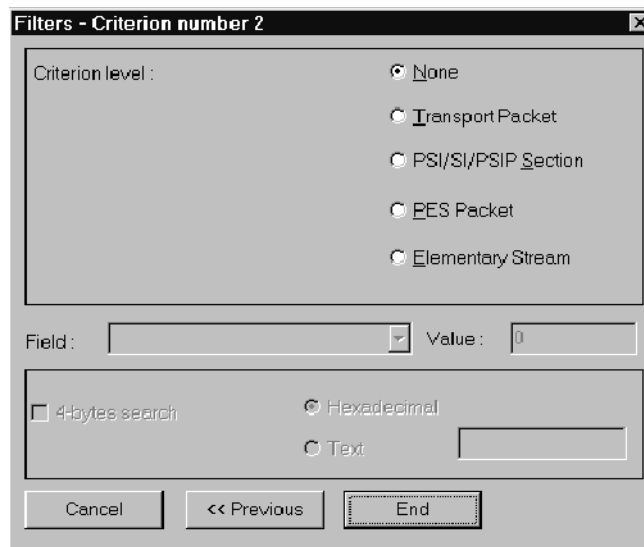

---

**NOTE.** Completion of the second through fourth criterion boxes is optional. The remaining filter definition steps let you add filter requirements. Strictly speaking, none of the additions is necessary, but a filter without at least two criteria would do no more than you could by double-clicking on a hierarchic view icon. The third and fourth filter criteria are optional but may help you narrow your search to exactly the packet or section you are interested in.

---



4. Use the second through fourth Criterion dialog boxes to fill in the blanks of one of the two following statements:
  - Each item I am looking for must be (or contain the part of) a [blank\_3] that has a [blank\_4] field with the value [blank\_5].
  - Each item I am looking for must be (or contain the part of) a [blank\_3] that contains the byte sequence [blank\_6].

Where blank\_3 is the Criterion level, blank\_4 is a selection from the Field drop-down list box, blank\_5 is a number entered in the (field) Value box, and blank\_6 is a hexadecimal or text value entered into the last value box when the “4 bytes search” check box is selected.

For example, you can make selections to complete the above statements in the following ways:

- Each item I am looking for must be a *PES packet* that has a *PTS/DTS flag* field with the value 3.
- Each item I am looking for must contain the part of a *PES packet* that contains the byte sequence *00 00 01*.
- Each item I am looking for must be a *transport packet* that contains the byte sequence *00 00 01 C0*.

Several conventions apply to this dialog box:

- Some criterion levels may not be available, depending on the output level specified in the first filter definition dialog box.
- The fields listed in the Field: drop-down list box depend on the criterion level selection.
- The Next button disappears when you select the Elementary Stream criterion level or the 4-bytes search check box because the filter cannot be any more specific than these selections.
- Selecting the Elementary Stream criterion gives you no further options; the Field drop-down list contains only Beginning of Access Unit (AU) and 4-bytes search is not available. Use Elementary Stream criterion to find either transport stream packets that contain the start of an AU or PES packets that contain the start of an AU.

5. Click **Cancel** to close the dialog box and omit the secondary criteria, click **<< Previous** to return to the previous filter definition dialog box, click **End** to complete the filter creation and end the session, or click **Next >>** to define up to two more filter criteria.

If you clicked **End** and forgot to name the filter, the dialog box below appears. Enter a name and click **OK** to complete the filter or click **Cancel** to terminate the session.



If you clicked **End** and the filter name already exists, the following dialog box appears. Enter a unique name for the filter or click **OK** to overwrite the existing filter with the new filter. Click **Cancel** to terminate the session.



**Saving a Filter**

Once a filter is defined, you can save it to a file and use it in another analysis.

1. Select **Filters** from the Selection menu; then select **Save** from the submenu. The Save filter dialog box appears. The dialog box shows all currently loaded filters.

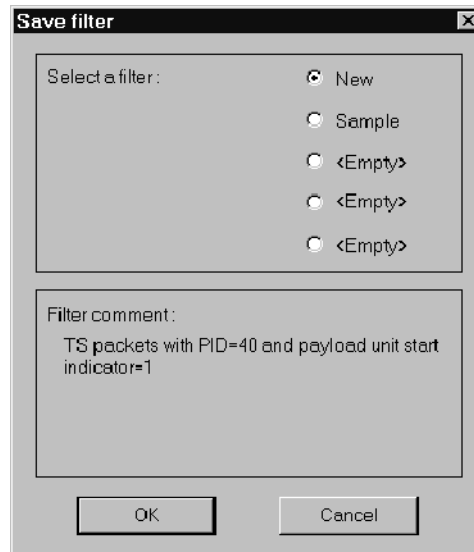

2. You can save up to five filters. Click the option button that corresponds to the filter you want to save; then click **OK**.
3. A standard Windows Save As dialog box opens. The filter name (with a \*.flt extension) appears in the File Name box. Click **OK** to accept the file name and save the filter file, or enter a different name and click **OK** to save the file under a new name.

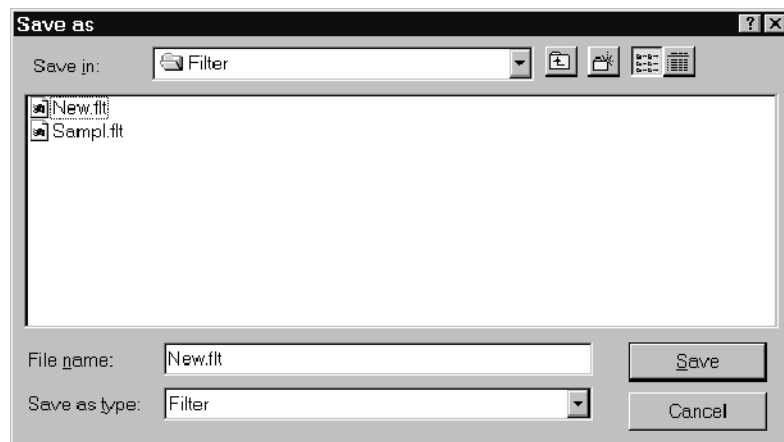

## Opening and Loading a Filter

Use the following procedure to open and load a previously saved filter.

1. Select **Filters** from the Selection menu; then select **Open** from the submenu.
2. If no more than four filters are already opened and loaded into the analyzer memory, the standard Windows Open dialog box appears. Select the desired filter as you would any document from within any Windows application (remember that the default filter file extension is \*.flt). Click **OK** to load the filter into analyzer memory.
3. If five filters are already loaded, the Open - Replace a filter dialog box appears. This dialog box shows the filters currently loaded into the analyzer memory. Select the filter you want to replace (with the filter you are about to open). Click **OK** to delete the filter.

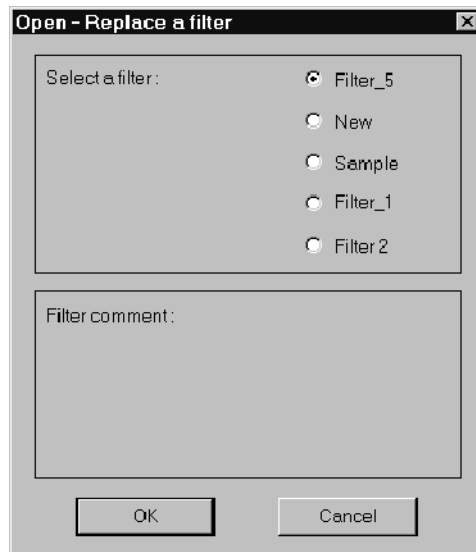

4. The Windows Open dialog box now appears; select and open the desired filter. Click **OK** to load the filter into analyzer memory.
5. The analyzer checks the selected file for a valid filter. If a filter is found, the Open filter dialog box appears.
6. Click **Yes** to store the filter into memory, click **No** to redisplay the Open dialog box to select a different filter, or click **Cancel** to abort the session.

**Editing a Filter** Use the following steps to edit an open filter.

1. Select **Filters** from the Selection menu; then select **Edit** from the submenu. The Edit filter dialog box appears.
2. Select a filter and then click **OK**. The first Filters - Criterion dialog box, containing the latest filter selections and settings, appears.
3. Proceed as if you were defining a new filter (see page 3-57). Change the existing selections and make new ones as necessary.
4. Click **End**.

If you change the filter name through the course of editing, the new name will replace the original name in the filter list dialog box. The previously saved filter file is not affected.

You can save the edited filter as described in *Saving a Filter* (above). Use the original name if you want to overwrite the old \*.flt file; enter a new name if you do not.

**Applying a Filter** Use the following steps to apply a filter to a transport stream.

1. Open an existing filter or create a new one.
2. Select the hierarchic view or a transport packet interpreted view.
3. Select **Filters** from the Selection menu; then select **Apply** from the submenu. The Apply filter dialog box appears.

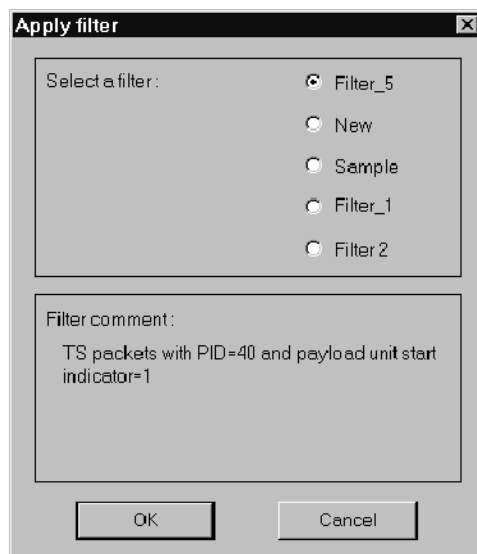

4. Click the option button that corresponds to the desired filter. The comment field applies to the selected filter.
5. Click **OK**. The analyzer displays an interpreted view of the first packet or section (if any) that satisfies all filter criteria.
6. Use the lower toolbar buttons to move among all stream items that meet the filter criteria. The full functionality associated with an interpreted view is available to obtain information on a particular MPEG-2 DVB/ATSC/ISDB-S/ARIB field.

The window heading identifies a filtered view. Messages at the top of the window provide useful information about the items found.

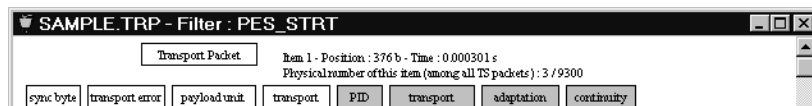

If the analyzer finds no item that matches all filter criteria, a message window indicates no matches.

## Extracting and Saving Stream Elements

You can extract transport packets, PES packets, PSI, SI, PSIP and ISDB-S/ARIB tables, and elementary streams from the current transport stream and save them to disk files for later use or analysis.

### Transport Packets

To save a portion of a transport stream, double-click on a hierarchic view TS (engine and tender) icon to open an interpreted view of the transport packets; then select **Save As** from the File menu or click the **Save** command button on the upper toolbar. The Save Transport Stream dialog box appears.

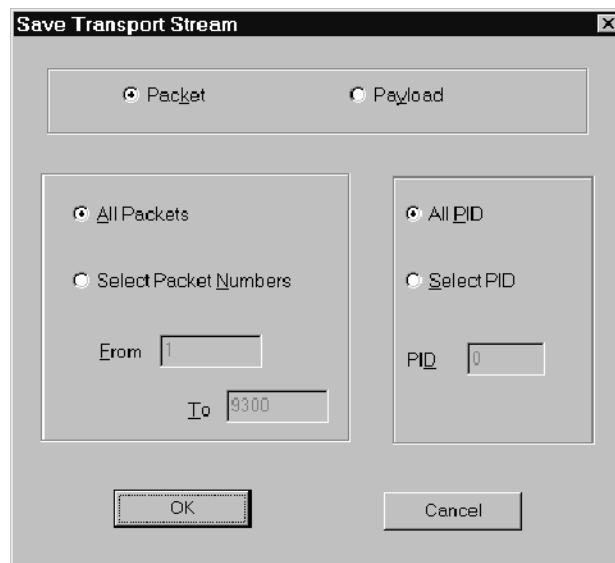

Make the appropriate selections and click **OK**. A standard Windows Save as dialog box opens with the file type set to Transport Stream (\*.trp). Select the appropriate drive and directory, enter a file name, and click **OK**.

**PES Packets** To save some or all of the packets in a PES stream, open an interpreted view of the PES and select **Save As** from the File menu. The Save Pes Stream dialog box appears.

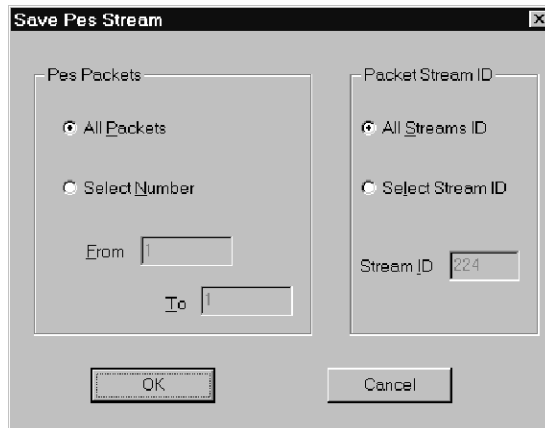

Make the appropriate selections and click **OK**. A standard Windows Save as dialog box opens with the file type set to Pes Stream (\*.pes). Select the appropriate drive and directory, enter a file name, and click **OK**.

**PSI, SI, PSIP and ISDB-S/ARIB Tables**

To save one or more sections of a particular table (PAT, PMT, NIT, SDT, for example) in the transport stream, double-click on the hierarchic view table icon to open an interpreted view of the section. (To save more than one section, click the **End** button on the lower toolbar to go to the last section and determine the number of sections in the stream.) Then select **Save As** from the File menu or click the **Save** command button. The Save sections dialog box appears.

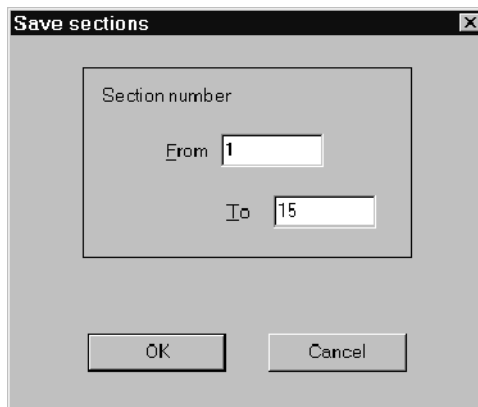



To save a particular section or sections, enter the appropriate From and To values (if you clicked the End button before choosing **Save As**, the number of the last section appears in the To box). Click **OK** to open A standard Windows Save as dialog box. The file type matches the type of section (for example, PAT/.pat). Select the appropriate drive and directory, enter a file name, and click **OK**.

### Elementary Streams

To save an elementary stream, double-click on a stream icon in the PSI hierarchic view or right-click one of the icons and select **Save** from the popup menu. The Save <Audio, Video.. > Stream dialog box appears with the file type set to match the type of stream. Select the appropriate drive and directory, enter a file name, and click **OK**.

A progress gauge opens to report the status of the save. To interrupt the save, click the **Abort** button.

**PES Extraction.** To save an elementary stream at the PES level, open an interpreted view of the PES and select **Elementary stream** from the Selection menu.

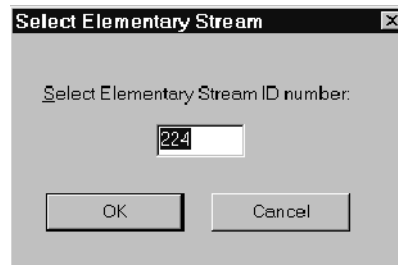

Enter the elementary stream ID number and click **OK**. The Save as dialog box appears with the file type set to match the type of stream. Select the appropriate drive and directory, enter a file name, and click **OK**.

A progress gauge opens to report the status of the save. To interrupt the save, click the **Abort** button.

## The Options Menu

The Options menu provides you a way to customize analyzer configuration and to save your configuration choices in a file so you can easily restore them in future analyzer sessions.

### **MPEG-2 DVB ATSC PSIP ISDB-S/ARIB**

Use these Options menu selections to specify the standard for analysis functions. Menu selections apply to open new files only; changing the standard does not alter files already opened.

Selecting DVB for example, activates/deactivates recognition of DVB syntax and semantics in new files.



When DVB is not selected, the analyzer interprets any DVB SI sections as private sections. Activate DVB when you are analyzing DVB SI streams; deactivate the selection only if you know the streams you are analyzing contain no DVB elements.

Likewise, selecting MPEG-2 or ATSC PSIP Terrestrial or Cable applies the selected standards to new file analyses and interprets any other sections as private sections.

### **GI-D Identification**

Use this selection when you know that the stream you are analyzing has Digicipher II video elementary streams. If this option is not selected and the stream has Digicipher II streams encoded, they are interpreted as private data streams.

### **AC3 Identification in DVB Mode**

Use this option to specify that Dolby Digital audio elementary streams be recognized as such in DVB mode. This is automatic in ATSC PSIP mode, and is not available in MPEG-2 mode.

### **Visual TSTD and LTW**

This selection determines whether the T-STD and LTW dynamic analyses are conducted in a window as visual buffer simulations or “in the background.” Refer to *Visual Mode* on page 3-47 for more information.

### **Unscrambling**

Switch the unscrambling option on and off.

**Output Messages in File**

Select this option to automatically save error messages and the contents of error message windows to a text file.

If this option is selected and you open a file of a transport stream with PAT CRC errors for example, the analyzer writes a list of the errors to a ASCII text file. The file receives the name of the transport stream file with a .log extension and is saved in the directory specified through the Options menu Directories command. You can read the \*.log file with an ASCII text editor, such as the Windows NT Notepad application.

The analyzer similarly creates a \*.log file and saves any message window error lists generated during stream analysis. Examples of error lists are those that can result when you conduct a syntax analysis or a consistency check.

Remember that selecting this option can, over time, result in many error log files in the Message directory. It is good practice to periodically delete outdated files.

**Base**

The Base command opens a dialog box for selecting the numeric base used in the hierarchic and interpreted views. **F2** is the shortcut key for toggling between the two settings.

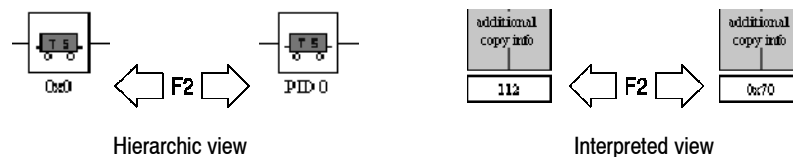
**Font**

Use the Font command in the Options menu to change the typeface used in the hierarchic and interpreted views. Choosing the command opens a dialog box for selecting font, style (normal, bold, italic), and size. Make your selections and click **OK**. The display changes immediately.

**Directories**

Use this command to specify default directories for output messages and configuration files. Enter the complete paths in the Message directory and Configuration directory text boxes; then click **OK**.

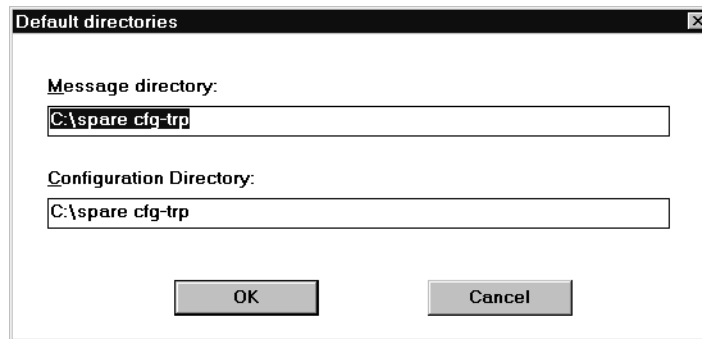

**Automatic Analysis** Use this command to configure the automatic analysis sequence. Refer to *Automatic Analysis*, beginning on page 3-54, for complete instructions.

**Interpretation** Select this command to control the information that appears in the transport packet, PES packet, and section interpreted views. See *Interpreted View Options* on page 3-26 for a full explanation.

**Configuration** All selections you make through the Options menu change the analyzer configuration. The configuration in use when you exit the analyzer application is restored the next time you start the program. The three configuration commands in the Options menu let you save one or more configurations to files for later use and allow you to easily return to the default configuration.

**Save Configuration.** Use Save configuration to save the current option settings to a file. A standard Windows Save as dialog box opens. Be sure to select a Drive and Directory that will make it easy to later retrieve the file; then enter a descriptive name for the configuration file and click **OK**. The file receives the extension \*.acf by default.

**Read Configuration.** Select Read configuration from the Options menu to restore a configuration file that you saved earlier. A standard Windows Open dialog box appears. Change the Drive and Directory if necessary and then select the file name. Click **OK** to restore the configuration saved in the file.

**Set Default Configuration.** Select Set default configuration to restore all default analyzer settings. A dialog box appears; click **OK** to confirm the command.

The following settings make up the default configuration.

**Table 3-25: Analyzer default settings**

Option	Default setting
DVB	Not selected.
Visual TSTD and LTW	Selected.
Output messages in file	Not selected.
Base	Decimal.
Font	Times New Roman, Regular, seven point.
Directories	See note below.
Automatic Analysis	All analyses selected.
Interpretation	Neither field Length nor Position displayed. All fields displayed for all types of interpreted view.

**NOTE.** When you select Set default configuration, the message and configuration directories are changed to the directory that contains the most recently opened file. This can cause confusion because the directories remain the same until you change them through the Options menu Directories command, read a saved configuration file, or (after opening a file from a different directory) again select Set default configuration.

## Message Window

The analyzer uses the Message for... (Message) window to report errors, warnings, and information about analyses performed in the hierarchic and interpreted view windows, one message per open stream.

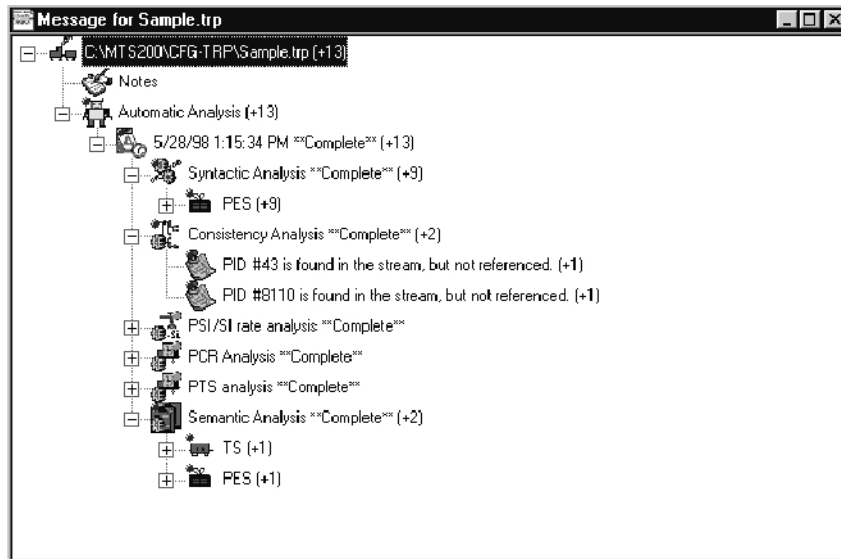

Messages are grouped by analysis type and displayed in a hierarchical tree within the message window. The nomenclature includes date and time, analysis level syntax, and error description. The number of erroneous packets detected is indicated between parentheses. You can save a message window with the File menu Save as command and view (interpreted view) or delete data with the popup menus.























---

**NOTE.** *If the number of nodes in the message window exceeds 10,000, the analyzer discards the remaining nodes; the number of nodes lost is documented in the final node at the bottom of the tree.*

---

**Identifying Icons** Table 3-26 identifies the analysis and element icon types used in the Message for... window.

**Table 3-26: MTS300 analysis and element icons**

Icon	Application name	Icon	Function
	Analyzed stream		Notes
	Date and time stamp		Automatic analysis
	Syntactic analysis		MPEG-2 PSI, DVB SI, ATSC PSIP, or ISDB-S/ARIB Consistency analysis
	PSI-Si rate analysis		PCR and PTS analysis
	Semantic analysis		T-STD analysis
	LTW analysis		CRC check
	Field incriminated in the message and subject of message		Message description
	TS packet type		PAT packet type
	PES packet type		PMT packet type
	NIT packet type	<i>PID</i>	PID number
	Program		Message Counter: records first, second, third, and last packet numbers of error occurrence.
	No errors found		Mega-frame analysis

**Error Reporting** Color-coded bullets accompany most reporting in the message window. Interpret the the icon bullets as follows:

- Green bullet: no errors detected
- Yellow bullet: warning
- Red bullet: errors detected

**Adding Notes** The message window has a *Notes* node at the top level of the tree. Double-click this node to open the Notes window. Type your comments in this window; the first sentence is automatically appended to the node identification when you close the window.

## Navigating the Message Window

The analyzer provides keyboard and mouse commands to help you navigate and review messages. Additional commands are also provided to sort, edit, and delete messages.

**Keyboard Commands.** Use the keyboard commands listed in Table 3-27 to navigate the message window.

**Table 3-27: Message window keyboard commands**

Press (key) to perform function	Function
HOME	Selects the top (root) node in the tree.
END	Selects the last node in the tree.
PAGE UP	Closes the next node of the tree.
PAGE DOWN	Opens the next node of the tree.
Arrow keys	
UP	Selects nodes upwards, vertically in the tree.
DOWN	Selects nodes downwards, vertically in the tree.
LEFT	Closes the preceding parents children upwards in the tree one node at a time.
RIGHT	Opens the proceeding parents children downwards in the tree one node at a time.
* (Asterisk), numeric keypad	Opens all children of the selected node.
- (Minus), numeric keypad	Closes the children of the selected node.
+ (Plus), numeric keypad	Opens the children of the selected node.

**Popup Menus.** Select a message in the message window with the left mouse button and then right-click to obtain a popup menu. You can perform the operations listed in Table 3-28 with the popup menus. The menu selection changes depending on the message selected.

**Table 3-28: Message window popup menus**

Popup menu	Function
View	Displays an interpreted view of the selected node. (Equivalent to double-clicking a node without children.) If the node does not contain enough information to open a view, the children are queried until sufficient information is recovered. If a view cannot be opened, a warning is issued.
Delete	Deletes the selected node and all of its child nodes. The message <i>!!! Error messages have been deleted in this node !!!</i> is appended to the parent list of the deleted node. The number of items appearing in parenthesis is not updated.



**Table 3-28: Message window popup menus (Cont.)**

Popup menu	Function
Refresh	Updates the number of errors entry (noted in parenthesis) following the deletion of warning messages by the Delete command. The number of errors for a node is the sum of the child errors.
Sort by PIDs/Sort by fields <sup>1</sup>	<i>Sort by PIDs</i> : Sorts the message window by PIDs; outputs a list of messages for each PID. <i>Sort by fields</i> : Sorts the message window by fields; outputs a list of PIDs for each message type.

<sup>1</sup> **Execute from the root level only.**

### Print the Message Window Contents

Select **Print** from the File menu to send the contents of the message window to a printer.

### Create a Message Window File

To write the contents of the message window to a file, select **Output messages in file** in the Options menu before you begin the analysis. The Save as dialog box will appear when you begin the analysis. Enter a <file name> and click **Save** to create a .LOG Error message file on disk.

If the number of nodes in the message window exceeds 10,000, the analyzer discards the remaining nodes and documents the number lost in the final node. If the **Output messages in file** option is on, messages written to a file will not be lost.

### Save a Message Window

Use the following procedure to save a message window to the hard drive.

1. Select **Save as** from the File menu or click



in the upper toolbar.

2. Select the storage location (drive/directory) in the Save in list box.
3. Enter a <file name> in the File name text box.
4. Select **Error messages** from the Save as type list box.
5. Click **Save**.



## Option CA

You can perform the following tasks when you add Option CA to the MPEG-2 DVB/ATSC/ISDB-S/ARIB System Analyzer:

- Unscramble stream components previously scrambled with either the DVB or CCETT algorithm. The Analyzer supports fixed control words and Viaccess ECMs. You must attach a PC2 Smartcard reader to the system computer to perform Viaccess unscrambling.
- Analyze various characteristics of Viaccess-compliant EMM (Entitlement Management Message) table sections in transport streams that contain DVB or CCETT scrambled components.

## Activating Option CA

If you purchased Option CA with your System Analyzer, it is already activated. If you are adding Option CA to the analyzer, you must perform the following steps to activate the option:

1. Exit the MPEG-2 DVB/ATSC/ISDB-S/ARIB System Analyzer if the application is running.
2. Double-click the **License Manager** icon in the Tektronix MPEG Test System program group window.

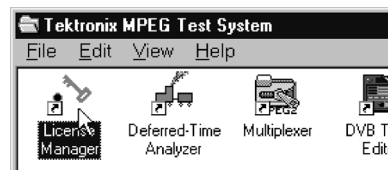

The Tektronix Software Protection window appears.



3. Consult the password document supplied with your Option CA upgrade kit and identify the General password. Enter the three 6-character Hexadecimal numbers of the password in the corresponding Tektronix Software Protection window entry fields (lowercase characters are acceptable) and then click **OK**. A License message window appears.
4. If the password is correct, click **OK** to acknowledge the message. If you made an error entering the password, click **OK** and return to step 2.

When you enter the correct password, Option CA is available the next time you start the the System Analyzer.

## Unscrambling with the MPEG-2 System Analyzer

To extract and save scrambled elementary stream files you must select the correct unscrambling parameters.

1. Open the transport stream (.trp) file.
2. To perform Viaccess unscrambling with an attached PC2 card reader, use the following procedure to load the EMM access rights into the PC2 card; otherwise, continue to step 3.
  - a. Double-click the EMM icon to open an interpreted view of the Entitlement Management Message section.
  - b. Select the PC2 dialog menu item, which is available when an EMM or ECM interpreted view is selected. A window opens to display the message *Are you sure you want to send this EMM to the PC2 card?*
  - c. Click **Yes** to send the EMM. You can now proceed with Viaccess unscrambling.
3. If Viaccess fixed control words were used to scramble the program of interest, use the following procedure to discover the control words; otherwise, continue to step 4.

- a. Double-click the PMT icon for the program to open an interpreted view of the program map table.

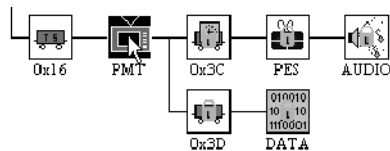

- b. In the PMT interpreted view, locate and double-click the CA descriptor field to open a descriptor window. Then identify the CA PID (7D2 in the example).

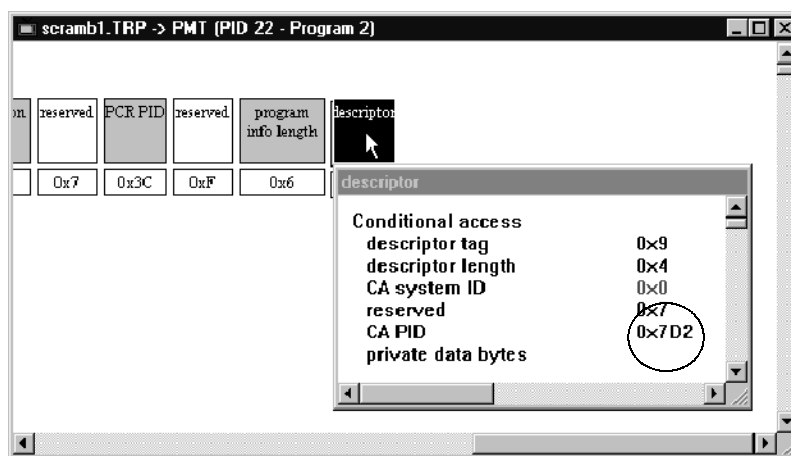

- c. Double-click the ECM icon to the right of the TS icon identified with the CA PID.

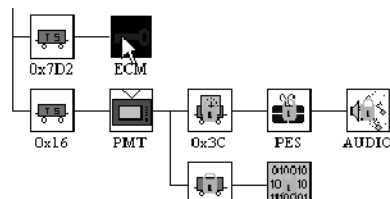

An interpreted view of the ECM section opens and the PC2 dialog menu item becomes available.

- d. Select the PC2 dialog menu bar item to retrieve the control words from the PC2 card reader.

- e. Carefully copy the control words that appear in the resulting PC2 dialog window for use in step 9 below; then click **OK** to close the window.
4. If *Unscrambling* does not appear on the Analyzer menu bar, select **Unscrambling** from the Options menu to create the menu bar item.
5. Click the Unscrambling menu bar item to open the Unscrambling parameters window.

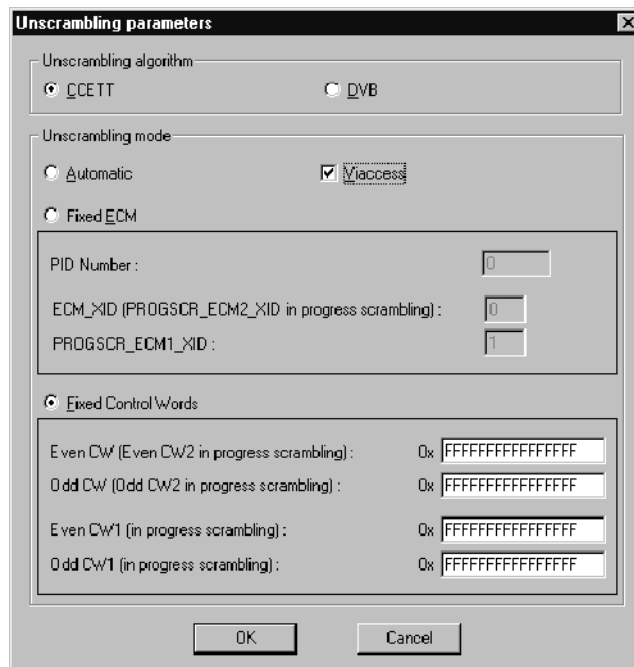

6. Select either the **CCETT** or **DVB** unscrambling algorithm.
7. Select **Viaccess** to use a PC2 card reader. (The reader must be attached to the COM1 port of the host computer.)
8. Select the unscrambling mode that is appropriate to the scrambling used during transport stream generation/encoding.

---

**NOTE.** The *Automatic* and *Fixed ECM* unscrambling modes are available only when *Viaccess* is selected.

---

**Automatic.** Select **Automatic** unscrambling mode when stream components have been scrambled with control words transported in the ECMs quoted in the PMTs. The Analyzer looks for the ECM demultiplexing information in the PMTs and, where necessary, the demultiplexed ECMs are sent to the PC2 card to decrypt the control words so they can be used for unscrambling.

**Fixed ECM.** Select **Fixed ECM** unscrambling mode when stream components have been scrambled with control words transported in special PID and ECM XID (PROGSCR ECM1 XID and PROGSCR ECM2 XID in progressive scrambling) ECMs. The Analyzer looks for the ECMs and, if necessary, they are sent to the PC2 card to decrypt the control words so they can be used for unscrambling.

**Fixed Control Words.** Select **Fixed Control Words** unscrambling mode when stream components have been scrambled with user-specified control words. In this case, you must also enter the hexadecimal control words: Even CW and Odd CW for standard unscrambling; or Even CW1, Odd CW1, Even CW2 and Odd CW2 for progressive unscrambling.

9. If you selected Automatic unscrambling mode, proceed to step 10.

If you selected Fixed ECM unscrambling mode, enter the associated parameters.

The screenshot shows a dialog box titled "Fixed ECM" with a radio button selected. It contains three input fields:

PID Number :	<input type="text" value="0"/>
ECM_XID (PROGSCR_ECM2_XID in progress scrambling) :	<input type="text" value="0"/>
PROGSCR_ECM1_XID :	<input type="text" value="1"/>

If you selected Fixed Control Words unscrambling mode, carefully enter the appropriate control words.

The screenshot shows a dialog box titled "Fixed Control Words" with a radio button selected. It contains four input fields for hexadecimal control words:

Even CW (Even CW2 in progress scrambling) :	0x	<input type="text" value="FFFFFFFFFFFFFFFF"/>
Odd CW (Odd CW2 in progress scrambling) :	0x	<input type="text" value="FFFFFFFFFFFFFFFF"/>
Even CW1 (in progress scrambling) :	0x	<input type="text" value="FFFFFFFFFFFFFFFF"/>
Odd CW1 (in progress scrambling) :	0x	<input type="text" value="FFFFFFFFFFFFFFFF"/>

10. Click **OK** to confirm your selections and close the Unscrambling parameters window.

Once you have entered the appropriate parameters for the open transport stream file, you can analyze scrambled stream components and save scrambled elementary streams.

## EMM Analysis

To conduct EMM analysis on a transport stream (.trp) file, you must enable Option CA (if necessary, refer to *Activating Option CA* on page 3-77), start the MPEG-2 DVB/ATSC/ISDB-S/ARIB System Analyzer (Deferred-Time Analyzer), and open a .trp file. Once a file is opened in the analyzer application window, there are four choices available on the Analysis EMM submenu: EMM selection, Diffusion rate, Diffusion holes, and Discontinuity. These choices also appear on the EMM hierarchy icon shortcut menu; right-click the icon to open the shortcut menu.

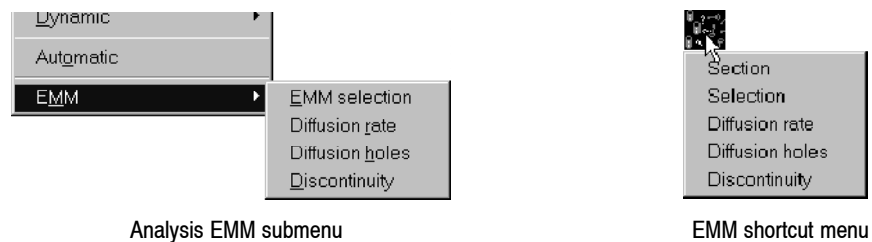

Use EMM selection first to specify the type(s) of EMM to analyze and the portion of the stream to examine. Then select the type of analysis to perform. You can initiate analyses through the shortcut menu only if the CA system (as identified in the CAT descriptor) is France Telecom's Viaccess system.

---

**NOTE.** You can perform analyses on non-Viaccess EMM sections through the Analysis EMM submenu, but the analysis results may not be accurate.

---

### EMM Selection

EMM selection allows you to choose EMM types (U, S, GH, or GA) and to select a particular portion of the transport stream for EMM analysis. The Analyzer uses these settings during diffusion rate, diffusion hole, and discontinuity analysis.

You can initiate EMM selection from either the Analysis menu or the EMM hierarchy icon shortcut menu (right-click to open the shortcut menu).

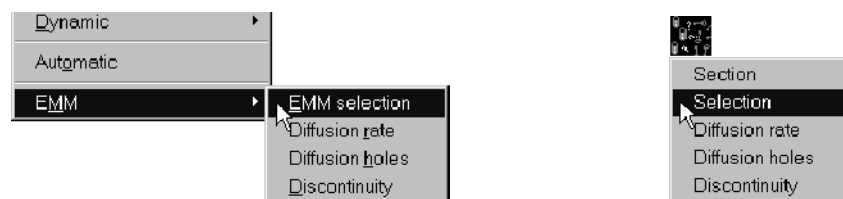



Both methods open the same EMM Viaccess selection panel window. Notice that the default selection is all EMM sections in the transport stream (.trp) file.

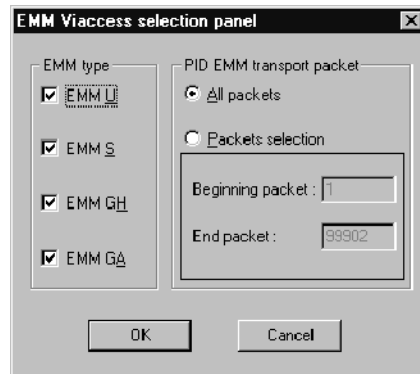

1. In the EMM type panel, select the type(s) of EMM you intend to analyze. There are four types:
  - EMM U: packets individualized for one customer.
  - EMM S: packets intended for a small number of customers.
  - EMM GH: packets for a group of customers.
  - EMM GA: packets for all customers.
2. To limit the portion of the transport stream for EMM analysis, choose **Packets selection** and then enter the beginning and ending packet number. The default beginning packet is the first transport packet in the .trp file; the default end packet is the last transport packet in the file.
3. Click **OK** to confirm your choices and close the window.

## Diffusion Rate Analysis

In diffusion rate analysis, the analyzer calculates EMM diffusion rates based on your EMM selection choices. If you make no EMM selection choices, the analyzer calculates diffusion of all EMM sections in the stream.

You can initiate diffusion rate analysis from either the Analysis menu or the EMM hierarchy icon shortcut menu (right-click to open the shortcut menu).

- **Shortcut Menu.** Select the **Diffusion rate** command from the shortcut menu. If the defining CAT descriptor designates the CA system as France Telecom (ID 1280), the Transport Stream Property window opens. If the CA System ID is not 1280, the following message appears:

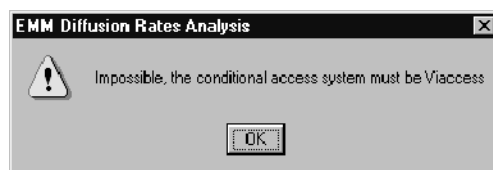

In this case, initiate diffusion rate analysis through the Analysis menu as described below.

- **Analysis Menu.** Open the Analysis menu and select **EMM**; then select **Diffusion rate** from the EMM submenu. The Analysis EMM – Diffusion rates window opens.

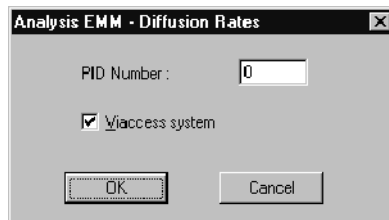

Select **Viaccess system** to instruct the analyzer to interpret the EMMs in accordance with the France Telecom CA system. Enter the PID of the EMMs that you want to analyze; then click **OK** to confirm your selections and conduct the analysis.

If the analyzer has not conducted a transport stream multiplex rate analysis since you opened the .trp file, the Transport Stream Property window opens.

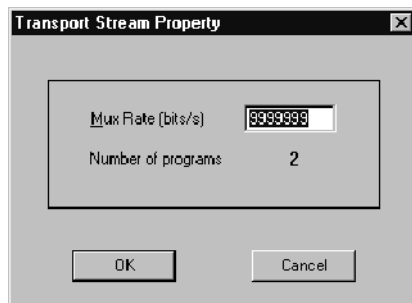

If necessary, enter the exact multiplex (Mux) rate and click **OK**. In the example, the exact multiplex rate is 10,000,000 bit/s instead of 9,999,999 that the analyzer calculated from the first ten PCRs found in the transport stream.

**NOTE.** Because the sample used is small and the precision of the number high, there can be error in the calculation. To ensure maximum accuracy of analyses that use the multiplex rate to calculate results and detect errors, you can enter the actual multiplex rate in the dialog box.

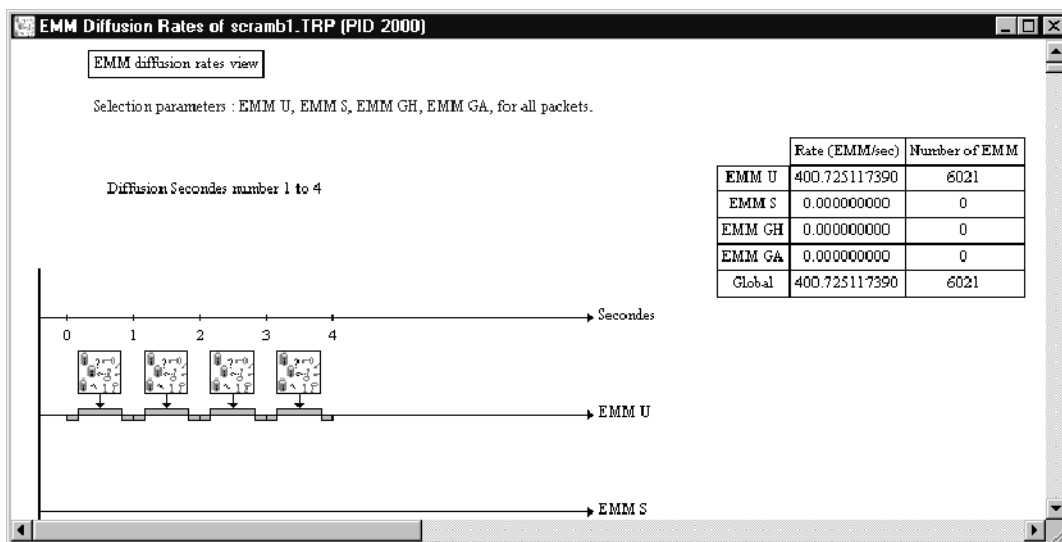

When you initiate the analysis, the EMM Diffusion Rates window opens in the application window.



The display lists (in blue characters) the EMM selection parameters applicable during diffusion rate calculation.

The table on the right side of the view lists the results of the diffusion rate calculation as well as the number of EMMs found for the calculation. The last line in the table lists the overall EMM rate and number for all EMM types combined.

A graphic representation of analysis results occupies the remainder of the window.

Symbol	Represents
	All EMMs of one type transmitted during a given second
	Diffusion holes at the start and end of a given second
	Diffusion of EMMs during a given second

On the time plot, EMMs are grouped by second and by type. The presence of an EMM icon on the axis for a particular EMM type, indicates that at least one EMM of that type was transmitted during the second in question. Where no icon appears, no EMMs were transmitted during this second.

Double-click an EMM icon to display information about the represented EMMs.

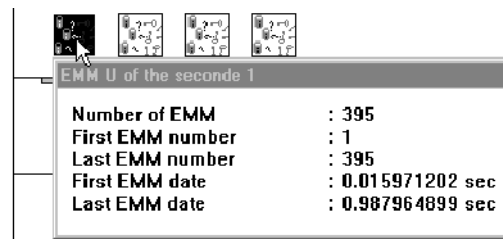

Double-click a Hole symbol to display the Hole duration.

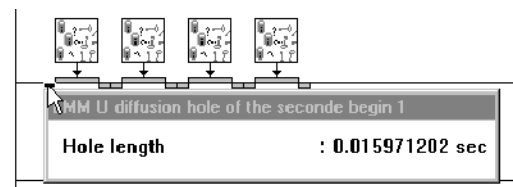

Double-click a Diffusion symbol to display the diffusion duration.

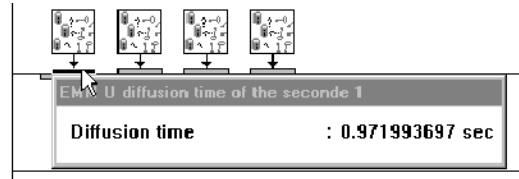

As in other item views, you can use the Edit (lower) toolbar command buttons to display subsequent seconds and navigate among results displays.

**Diffusion Rates Algorithm.** The algorithm used to calculate diffusion rates for the different EMMs is as follows:

For a given selection, X is the selection start packet position and Y is the selection end packet position. If the selection includes all EMM PID TS packets, then X = 1 and Y = the position of the last EMM PID TS packet.

```
PID_EMM = CAT(Eurocrypt);
nb_EMM_U = 0;
nb_EMM_S = 0;
nb_EMM_GH = 0;
nb_EMM_GA = 0;
nb_EMM_total = 0;
nb_TS_packets = 0;
```

Do for all TS packets in the TS stream from packet X to packet Y

```
nb_TS_packets++;
if PID of packet TS == PID_EMM & payload_unit_start_indicator==1(i.e.
start of EMM) then

    select case according to EMM type:
        EMM_U : nb_EMM_U++;
        EMM_S : nb_EMM_S++;
        EMM_GH : nb_EMM_GH++;
        EMM_GA : nb_EMM_GA++;
    end select;

end if;

end do;

EMM_U_rate = (Stream_rate/nb_TS_packets)*nb_EMM_U;
EMM_S_rate = (Stream_rate/nb_TS_packets)*nb_EMM_S;...
```

### Diffusion Hole Analysis

In diffusion analysis, the analyzer searches for and identifies EMM diffusion holes. The search is carried out based on your EMM selection choices (see *EMM selection* on page 3-82). If you make no EMM selections, the analyzer searches the entire transport stream (.trp) file. You can initiate diffusion hole analysis from either the EMM hierarchy icon shortcut menu or the Analysis menu.

**Shortcut Menu.** If you know that the transport stream uses the France Telecom Viaccess CA system, right-click the EMM hierarchic view icon to open the shortcut menu; then select the **Diffusion holes** command. An Analysis EMM – Diffusion Holes window opens.

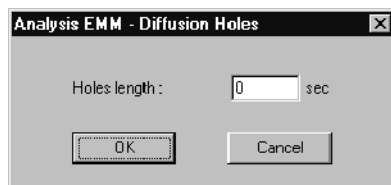

Enter the minimum duration hole to search for and then click **OK**. If the CA system identified in the CAT is not Viaccess, the following message appears:

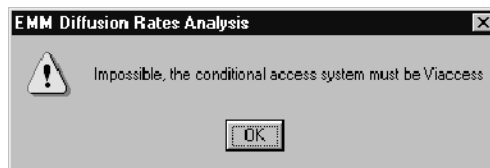

In this case, initiate diffusion rate analysis through the Analysis menu, as described below.

**Analysis Menu.** To initiate diffusion hole analysis through the Analysis menu, open the menu and select **EMM**; then select **Diffusion holes** from the EMM submenu. Another Analysis EMM – Diffusion Holes window opens.

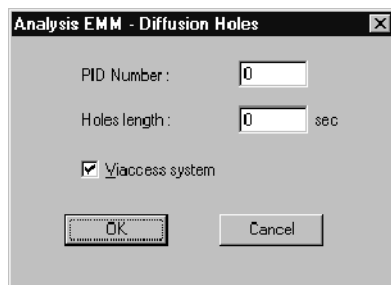



Enter the appropriate EMM PID and the minimum hole duration to search for. Select **Viaccess system** to instruct the Analyzer to interpret the EMMs in accordance with the France Telecom CA system. Click **OK** to confirm your choices and start the analysis.

If you have not performed an analysis (since opening the .trp file) that calculates the transport stream multiplex rate, the Transport Stream Property window opens as shown on page 3-85. If necessary, enter the correct multiplex rate and click **OK** to continue.

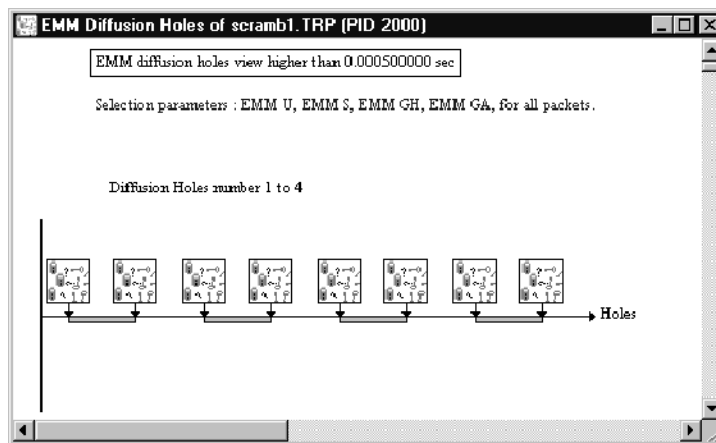
If the analyzer finds diffusion holes longer than the minimum duration, an EMM Diffusion Holes view appears.



The display lists (in blue characters) the EMM selection parameters applicable to the diffusion hole search. A graphic representation of analysis results occupies the remainder of the window.

Symbol	Represents
	An EMM at the start or end of a diffusion hole
	An EMM diffusion hole

Double-click an EMM icon to display information about the EMM at the beginning or end of a diffusion hole.

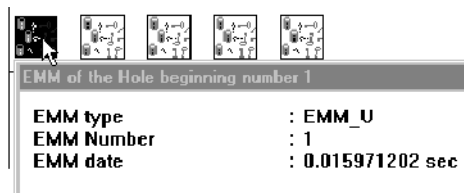

Double-click the Hole symbol to display the Hole duration.

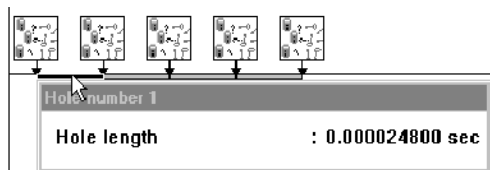

As in interpreted views, use the Edit (lower) toolbar buttons to display subsequent EMM diffusion holes.

### Diffusion Discontinuity Analysis

In diffusion discontinuity analysis, the analyzer searches for EMM diffusion discontinuities. The search is carried out based on your EMM selection choices (see *EMM selection* on page 3-82). If you make no EMM selections, the analyzer searches the entire transport stream file.

The analyzer can search for two discontinuity types:

- Address discontinuity, in which type U or type S EMM destination addresses are not increasing and sequential. The search can be for increasing (but not sequential) addresses, or for all increasing, decreasing and equal addresses.
- Type discontinuity: The analyzer searches EMMs off all types for EMM type transitions.

You can initiate diffusion discontinuity analysis from either the EMM hierarchy icon shortcut menu or the Analysis menu.



**Shortcut Menu.** If you know that the transport stream uses the France Telecom Viaccess CA system, right-click the EMM hierarchic view icon to open the shortcut menu; then select the **Discontinuity** command. An Analysis EMM window opens.

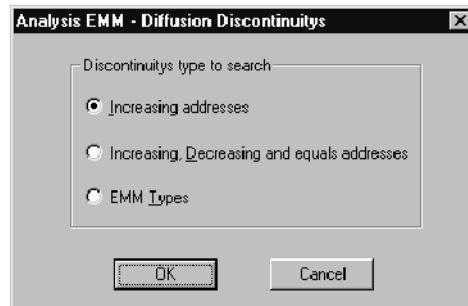

Select the type of discontinuity to search for and then click **OK**. If the CA system identified in the CAT is not Viaccess, the following message appears.

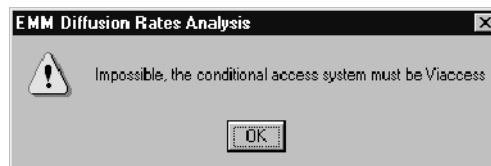

In this case, initiate discontinuity analysis through the Analysis menu as described below.

**Analysis Menu.** Open the Analysis menu and select **EMM**; then select **Discontinuity** from the EMM submenu. Another Analysis EMM window opens.

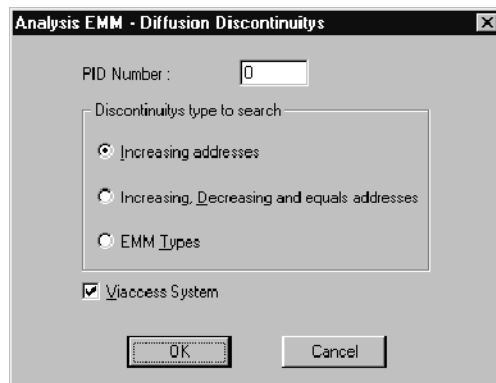



Enter the appropriate EMM PID and select the discontinuity type to search for. Select **Viaccess system** to instruct the analyzer to interpret the EMMs in accordance with the France Telecom CA system. Click **OK** to confirm your choices and conduct the analysis.

If you have not performed an analysis (since opening the .trp file) that calculates the transport stream multiplex rate, the Transport Stream Property window opens as shown on page 3-85. If necessary, enter the correct multiplex rate and click **OK** to continue.

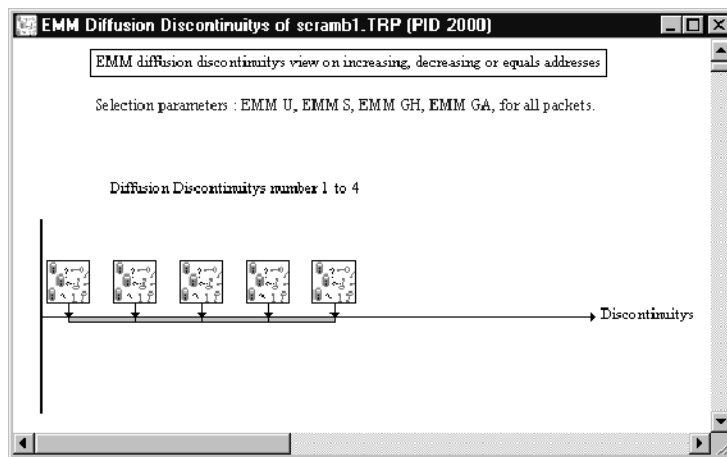
If the analyzer finds discontinuities in the stream, the EMM Diffusion Discontinuities view opens.



The display lists (in blue characters) the EMM selection parameters applicable to the diffusion discontinuity search. A graphic representation of analysis results occupies the remainder of the window.

Symbol	Represents
	An EMM at the start or end of a discontinuity
	A diffusion discontinuity

Double-click an EMM icon to display information about the EMM at the beginning or end of a discontinuity.

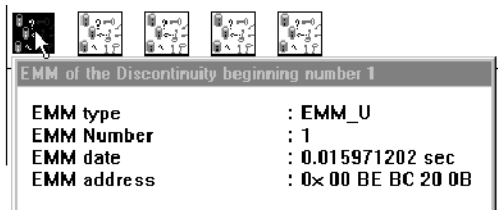

Double-click the Discontinuity symbol to display the Discontinuity type and duration.

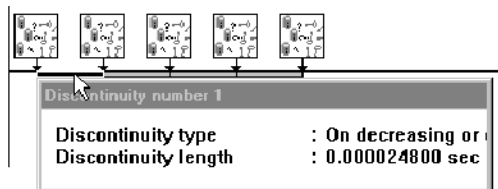

As in other item views, you can use the Edit (lower) toolbar command buttons to examine subsequent discontinuities.



# DVB Channel Coding and Decoding

The European Digital Broadcasting Project (DVB) specifies a baseline system for satellite broadcasting. The transport stream channel coding portion of the specification has the following flow:

- MPEG-2 Transport stream file (Multiplexer)
- Energy Dispersal — randomizing
- Outer Coder RS (204, 188) — for byte error correction
- Interleaver — better burst error correction
- Inner Coder (Viterbi p/q) — bit error correction
- QPSK Modulator

The DVB Channel Coding and Decoding application also provides decoding to return the coded file to a standard transport stream file.

Table 3-29 lists the type of coding/decoding, the type of input expected, and the resulting file.

**Table 3-29: Expected input file types**

Operation	Expected input	Output
Energy Dispersal	*.trp	*.eds
Reed-Solomon	*.eds	*.res
Byte Interleaving	*.res	*.inl
Viterbi Encoding	*.inl	*.vtb
Byte Deinterleaving	*.inl	*.din
Reed-Solomon decoding	*.din	*.drs
Energy Dispersal removal	*.drs	*.edr

## Starting the Application

Double-click the **DVB channel Coding & Decoding** icon in the Tektronix MPEG Test System program group window to start the application. The application window opens as shown below.

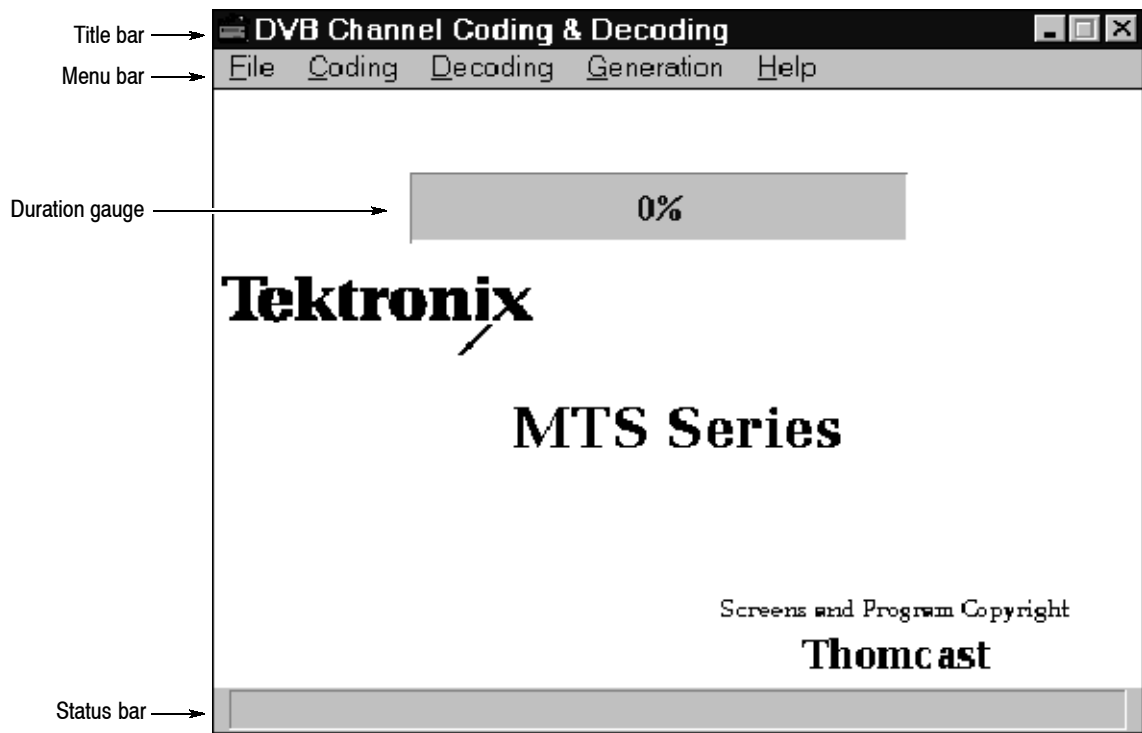

**Menu Bar.** Use the cursor to access the application main menus.

**Duration Gauge.** Displays the coding or decoding process status in percent.

**Status Bar.** Displays a brief explanation of a menu entry when you position the cursor over a menu selection in the Menu bar.

## Menu Commands

Figure 3-30 lists the DVB Channel Coding and Decoding menu commands.

**Table 3-30: DVB Channel Coding and Decoding menu commands**

Menu	Commands	Function
File	Quit	Exits the Coder/Decoder application
Coding	Chain	Defines a list of coding modules
	Energy Dispersal	Defines and performs Energy Dispersal coding on a selected file
	Reed-Solomon	Defines and performs Reed-Solomon coding on a selected file
	Interleaver	Defines and performs Interleaver coding on a selected field
	Viterbi	Defines and performs Viterbi coding on a selected file
Decoding	Chain	Defines a string of decoding modules for a file
	DeInterleaver	Decodes a file for Interleaver coding
	Reed-Solomon	Decodes a file for Reed-Solomon coding
	Energy Dispersal Removal	Decodes a file for Energy Dispersal coding
Generation	Pattern	Generates a user-defined repetitive pattern and puts it in a file
	Transport Packet	Generates a user-defined pseudo transport packet and puts it in a file
Help	Contents	Open a Help window and display the table of contents
	Using Help	Provides general information on how to use the Help system
	About...	Displays the application version and copyright

**File Menu** The File menu offers the Quit command, which closes the application.



**Coding Menu**

The Coding menu provides access to the required DVB channel coding for satellite broadcasting (Energy Dispersal, Reed-Solomon, Interleaver, and Viterbi). It also provides for chaining the various coding methods together.



**Chain.** The Chain command opens the Coding Chain dialog box, which allows you to create DVB-compliant files.

Each check box defines one module in the coding chain. When all check boxes are selected, the coding will produce a DVB-compliant file. If you deselect any of the check boxes, you will generate a non-compliant file. (This feature is provided for testing purposes.)

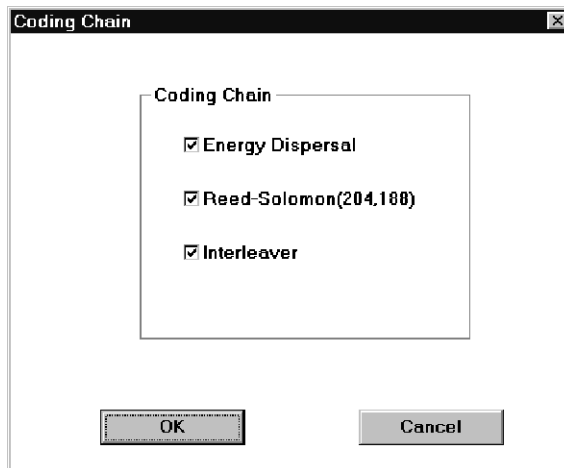

---

**NOTE.** If Energy Dispersal is not selected, it is replaced by a “B8 sync byte add only” module in the chain.

---

When you select **OK**, the Open dialog box appears. Identify the file to code.

Although all file types (\*.\*) are available, the expected transport stream file type for DVB compliance is \*.trp. Use a file created by the Multiplexer application or acquire one from a transport stream input through a rear-panel connector.

Select **OK** to initiate the coding process. Each coding module is performed in the order given in the dialog box. During the coding process, a gauge in the



Application Window reports the coding status. The gauge range is 0% to 100% for each type of coding.

---

**NOTE.** To stop the coding process at any time, press the ESC key. This ends the coding with the current coding module.

---

The *READY* statement in the status bar indicates that the coding process is complete for the selected modules. There are now three additional files in the original directory with the transport stream file. The new files share the original name with the following extensions: \*.eds, \*.res, and \*.ini.

For more information on individual coding modules, see *Energy Dispersal Coding* on page 3-107, *Reed-Solomon Coding* on page 3-108, and *Convolutional Interleaving Coding* on page 3-108.

**Energy Dispersal.** The Energy Dispersal command allows you to use this coding scheme alone, instead of in conjunction with the other code modules using the Chain command. This module performs sync byte inversion for the first of each group of eight transport packets, and randomizing of data using a PRBS (Pseudo Random Binary Sequence). For more information on the actual coding, refer to *Energy Dispersal Coding* on page 3-107.

Selecting Energy Dispersal opens the following dialog box.

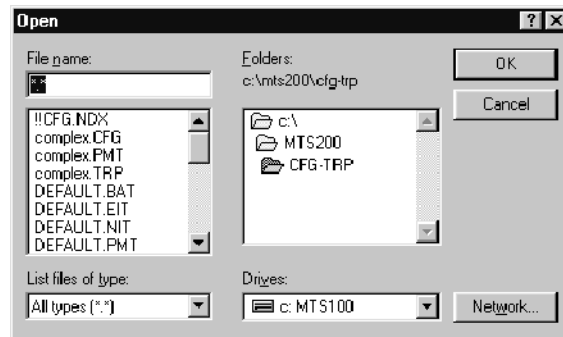

This first byte of the selected input file should be the first byte of a transport stream packet file (the sync byte, 47<sub>HEX</sub>). The input file should be a \*.trp transport stream file. Other file types are permitted, as long as they meet the sync byte requirement, however.

Click **OK** to begin the coding process. A gauge in the Application Window states the coding process status. When the gauge reads 100% and *READY* is displayed in the Status bar, the coding process is complete.

Completion of the coding results in a file with the same base name as the original, except the extension is \*.eds.

If you select a file that is inappropriate for Energy Dispersal, coding will occur anyway. You can stop the coding process at any time by pressing the **ESC** key.

**Reed-Solomon.** Reed-Solomon coding takes the randomized transport packet (from the Energy Dispersal coding) and adds 16 bytes to the field. (188 initial packet size + 16 bytes of Reed-Solomon = 204 bytes.) For a more detailed explanation of Reed-Solomon coding, see Reed-Solomon Coding on page 3-108.

The **Reed-Solomon** dialog box is displayed after choosing this command. Enter the desired Coded Block Size and Size of Block to Code in the appropriate text boxes. The maximum for both parameters is 255. The default values (204 and 188) are correct values for DVB.

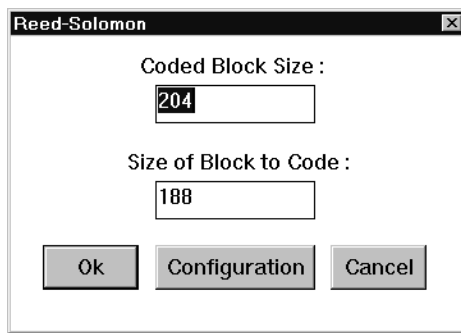

If you choose the **Configuration** command, the Reed-Solomon Configuration dialog box appears.

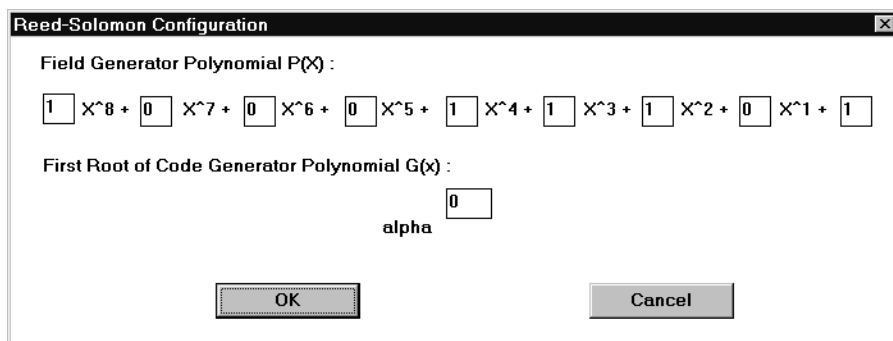

Use the **Reed-Solomon Configuration** dialog box to define different values for  $p(x)$  (the Field Generator Polynomial) and  $\alpha$ , which is the first root of  $p(x)$ . The default values are correct for DVB applications.

When the configuration is complete, return to the Reed-Solomon dialog box by selecting **OK**. If you are ready to code a file, select **OK**. This returns the Open dialog box. The coding module accepts \*.eds files (previously Energy Dispersal coded) only.

Select a file and enter it in the File Name text box; then click **OK**. This initiates the Reed-Solomon coding process. The Application Window gauge tracks the progress of the coding process. When coding is complete, the gauge reads 100% and the Status bar reads **READY**.

The coding process outputs a file with the original name and an added \*.res extension.

**Interleaver.** This module performs convolutional byte interleaving. See page 3-108 for more information on this coding process.

When you choose the **Interleaver** command, the Open dialog box appears. There are no parameters to adjust for this coding module.

The Interleaver requires a \*.res file (a file previously Reed-Solomon encoded). After selecting a **file to code**, click **OK**. This starts the Interleaver coding module.

A gauge in the Application Window monitors the coding progress. Coding is complete when the gauge reads 100% and the Status bar reads **READY**. Interleaver coding results in a file with the same base name as the selected file, except the extension is \*.inl.

**Viterbi.** Viterbi performs inner coding based on the Viterbi punctured convolutional code. For more information on this coding process, refer to *Viterbi Coding* on page 3-109.

---

**NOTE.** *This application does not provide a method to decode Viterbi coding.*

---

When you select **Viterbi**, the following dialog box appears.

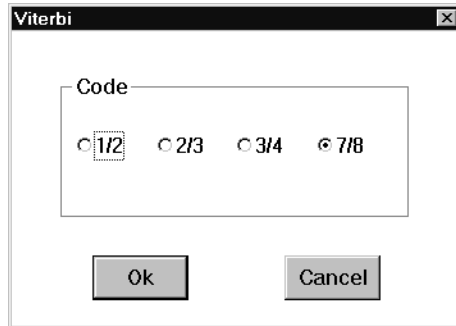

Use the Viterbi dialog box to select the **Viterbi Code**. The code can be 1/2, 2/3, 3/4, or 7/8 (the default is 7/8). When you click **OK**, the Open dialog box appears.

Use the **Open** dialog box to select a file for Viterbi coding. The expected file type is an \*.inl (Interleaver coding result). Once you select the file, click **OK**. This begins the Viterbi coding process.

A gauge in the Application Window tracks the progress of the coding. The coding is complete when the gauge reads 100% and the Status bar says *READY*. The output of this module is a file with the same base name as the original file, but it now has \*.vtb as the extension.

### Decoding Menu

The Decoding menu provides access to the required DVB Channel Decoding for satellite broadcasting (Deinterleaving, Reed-Solomon Decoding, and Energy Dispersal Removal). It also provides for chaining the various decoding methods together.

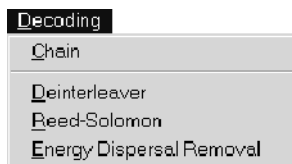

**Chain.** With the Chain command, you can decode the transport stream file using the DVB-compliant method. The figure below shows the dialog box associated with the Chain command.

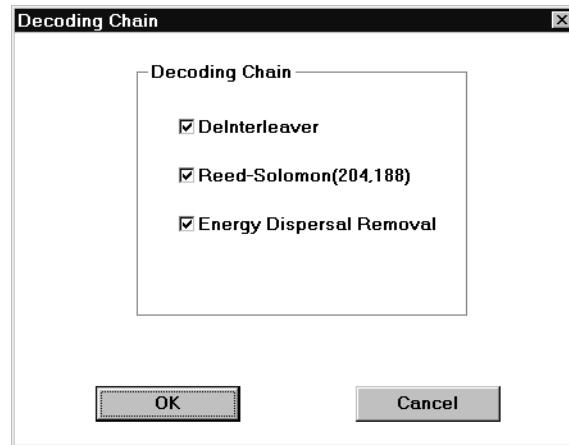

You can deselect any of the check boxes, however, all boxes must be checked to generate a DVB-compliant file. You purposely deselect modules to create DVB non-compliant files for testing purposes.

Choose **OK** to begin Chain decoding. A gauge in the Application window reports the progress of each decoding operation. All chain decoding is complete when the gauge reads 100% and the status bar says *READY*.

If the Energy Dispersal Removal module is not selected, it is replaced by a B8 sync byte removal module in the chain.

To stop the decoding process at any time, press the **ESC** key. This ends the entire decoding chain with the current module.

**Deinterleaver.** When you select the Deinterleaver command, the **Open** dialog box appears. The expected input file is one generated by the Interleaver coding module (\*.inl), although the Deinterleaver module will accept any file.

When you click **OK**, Deinterleaving begins. A gauge in the Application window reports the decoding process status. Decoding is complete when the gauge reads 100% and the Status bar says *READY*. The resulting file has the same name as the original, with the extension \*.din added.

To end the decoding at any time, press the **ESC** key.

**Reed-Solomon.** When you select the Reed-Solomon command, the Open dialog box appears. The expected input file is one generated by the Deinterleaver coding module (\*.din).

When you click **OK**, Reed-Solomon decoding begins. A gauge in the Application window tracks the decoding process status. Decoding is complete when the gauge reads 100% and the Status bar says *READY*. The resulting file has the same name as the original, with the extension \*.drs.

To end the decoding at any time, press the **ESC** key.

**Energy Dispersal Removal.** When you select the Energy Dispersal Removal command, the **Open** box appears. The expected input file is one generated by the Deinterleaver coding module (\*.drs), although this decoding module will accept any file type.

When you click **OK**, Energy Dispersal Removal decoding begins. A gauge in the Application window tracks the decoding process status. Decoding is complete when the gauge reads 100% and the Status bar says *READY*. The resulting file has the same name as the original, with the extension, \*.edr added.

To end the decoding at any time, press the **ESC** key.

## Generation Menu

The Generation menu allows you to create new \*.trp files by defining a pattern or transport packets.

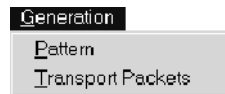

**Pattern.** This command generates a user-defined pattern. When you select the Generation Pattern command, the Save As dialog box appears to name the file. A default extension is not provided for the file name. However, if you enter a file name without an extension, \*.plp is automatically added.

Click **OK** to confirm the entry and close the dialog box. The Pattern entry box appears; enter the number of bytes in the pattern and click **OK**.

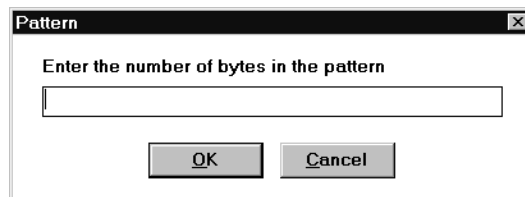

The **Composition Motif** entry box appears to define the repetitive pattern. Enter the desired byte value in hexadecimal. One Composition Motif dialog box appears for each byte you specified in the pattern.

Click **OK** to confirm the entry and close the dialog box.

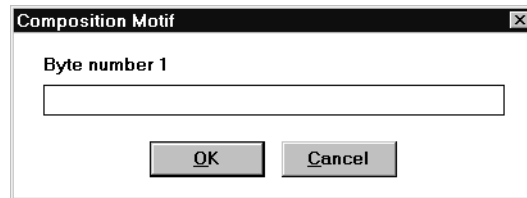

The Pattern entry box appears. Define the number of times you want the pattern to repeat; then click **OK**.

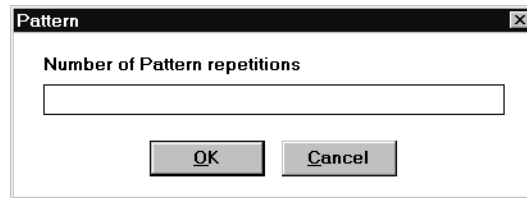

The pattern is created and stored in the file specified above.

**Transport Packet.** This command generates a repetitive pattern of user-defined transport packets.

When you select the **Transport Packet** command, The Transport Packets dialog box appears to define the payload or to have random data loaded.

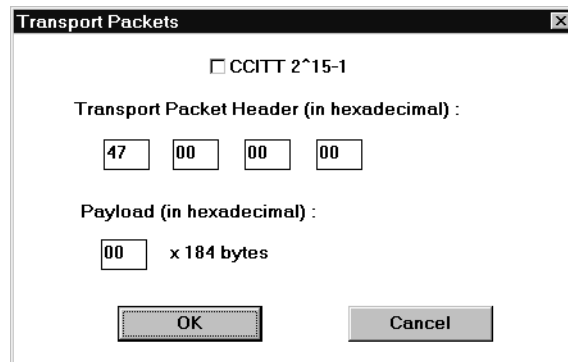

If you select the CCITT 2<sup>15</sup>-1 check box, random data is generated for the payload. If you set the value of the first text box under the Transport Packet Header, the last three text boxes will be dimmed. The default value of the first text box is 47. You can also enter a value.

If the CCITT 2<sup>15</sup>-1 check box is not selected, you can define the values of all text boxes under the Transport Packet Header. The default value is 47 00 00 00. You must define the payload, which is then repeated 184 times. Click **OK** to confirm the selections.

The Number of Packets dialog box appears.

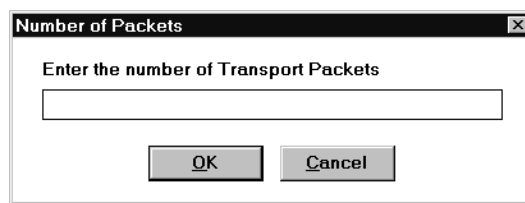

Enter the number of transport packets in the transport stream; then click **OK**. The Save As dialog box opens to name the file. A default extension is not provided for the file name. However, if you enter a file name without an extension, \*.plp is automatically added.

Click **OK**, the application creates the desired transport stream file. When the Gauge reads 100%, the transport stream file is complete.

## Help Menu

The Help menu commands provide access to the Help system.

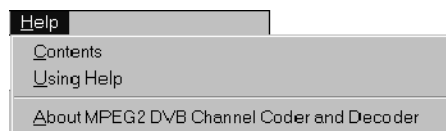

**Contents.** Displays the Help system table of contents.

**Using Help.** Provides information on how to use the Help system.

**About MPEG2 DVB Channel Coder and Decoder.** Displays the application version and copyright.



## Coding Types

This section defines the application coding types.

### Energy Dispersal Coding

This is the first coding module and last decoding module.

The input of this coding module is an MPEG-2 transport stream, which is a concatenation of packets of 188 bytes (1 sync byte plus 187 data bytes).

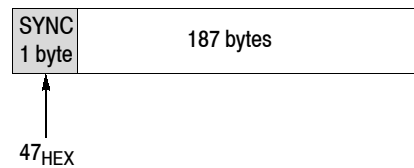

To comply with DVB and ensure adequate binary transitions, the data from the MPEG-2 multiplex (transport stream file) is scrambled with a Pseudo Random Binary Sequence (PRBS). The processing order at the transmitting side always starts from the Most Significant Bit (MSB) of the synchronization byte (0 of 01000111).

The polynomial for the PRBS generation is :  $X^{15} + X^{14} + 1$ . It uses the 15-bit shift register illustrated below for scrambling and descrambling (in the channel coding process).

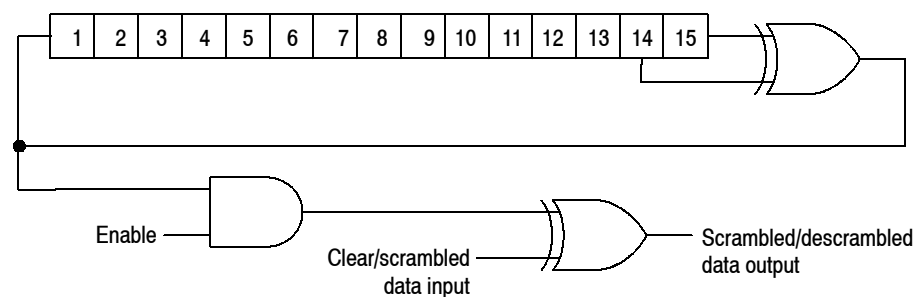

At the start of every eighth transport packet, the sequence 100101010000000 loads into the shift register. This provides an initialization signal for the descrambler. The MPEG-2 sync byte (for the first transport packet in the group of eight packets) is then inverted bitwise from 47<sub>HEX</sub> to B8<sub>HEX</sub>. The first bit at the output of the PRBS generator is applied to the first bit (MSB) of the first byte following the inverted MPEG-2 sync byte (B8<sub>HEX</sub>).

To optimize synchronization of the subsequent seven transport packets, PRSB generation continues with its output disabled, leaving these bytes unrandomized. Thus the period of the PRSB sequence is 1503 bytes as shown below.

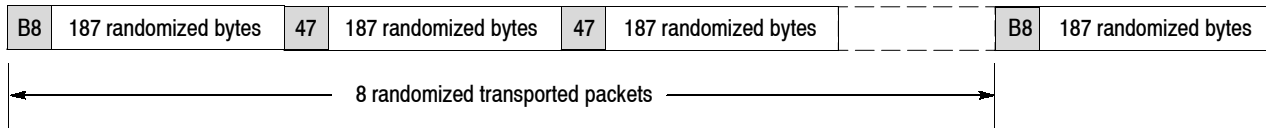

**Reed-Solomon Coding**

The Reed-Solomon RS (204, 188) code corrects up to 8 bytes in a 204 byte block. This module takes each randomized transport packet at the output of the Energy dispersal module and produces 204 bytes by calculating and adding 16 bytes at the end of the packet (188 bytes).

The Reed-Solomon calculates in a Gallois Field generated by the polynomial:

$$p(x) = x^8 + x^4 + x^3 + x^2 + 1$$

The RS code generator polynomial (used for the 16 byte calculation) is:

$$g(x) = (x + \alpha^0)(x + \alpha^1) \dots (x + \alpha^{15})$$

where  $\alpha = 02_{\text{hex}}$

The RS (204,188), shortened code from the original RS (255,239), is implemented by adding 51 bytes, all set to zero, before the information bytes (a transport packet) at the input of an RS (255, 239) encoder. After the RS coding procedure, these null bytes are discarded, and the transport packet remains as shown in the following illustration.

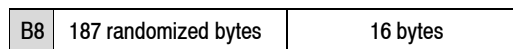

**Convolutional Interleaving Coding**

Convolutional Interleaving, with depth I = 12, is applied to the error protected packets. The following is a conceptual diagram of the Interleaver.

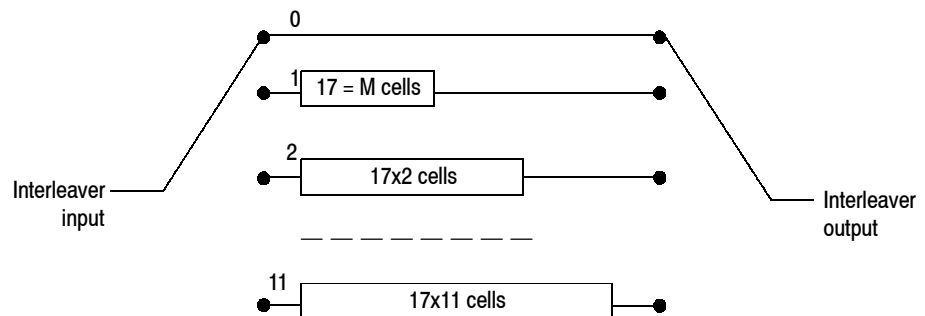

The Interleaver has 12 branches, cyclically connected to the input byte-stream by the input switch. Each branch is a FIFO shift register, with depth (MJ) cells.

where  $M = 17$  or  $N/I$   
 $N = 204$  the error protected frame length  
 $I = 12$  the interleaving depth  
 $J =$  branch index

The cells of the FIFO contain 1 byte, and the input and output switches are synchronized.

For synchronization purposes, the sync bytes and the inverted sync bytes are always routed in the branch “0” of the Interleaver (corresponding to a null delay).

The Deinterleaver is similar to the Interleaver, but the branch indexes are reversed ( $j = 0$  corresponds to the largest delay). The deinterleaver synchronization can be carried out by routing the first recognized sync byte in the “0” branch. The following diagram shows the interleaved transport packets.

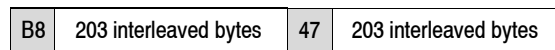

**Viterbi Coding**

The inner coding is based on a Viterbi punctured convolutional code as diagrammed below.

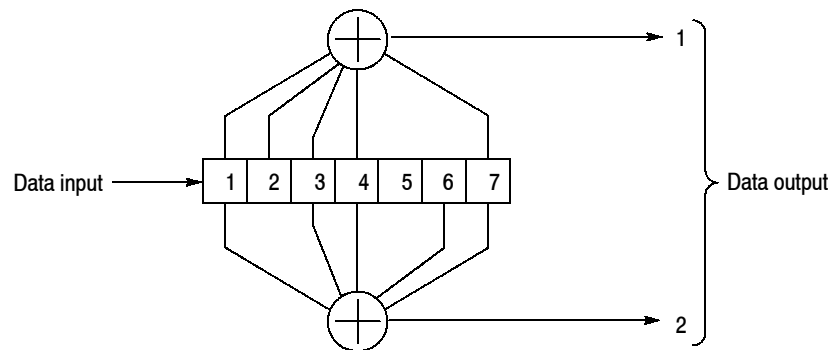

Each byte of the input stream (MSB first) loads in a 7 ( $K = 7$ , constant length) bit shift register. It then executes two polynomial operations. To produce a  $p/q$  code ( $q$  output bits for  $p$  input bits) a “puncture” is applied to the output of the  $1/2$  coder.

For example, in  $7/8$  mode, 7 bits produce 14 bits of  $1/2$  code and only 8 are transmitted. (The puncture pattern for  $7/8$  is 11010101100110.)



# TMCC Deferred-Time Client Reference

The TMCC (Transmission and Multiplexing Configuration Control) Deferred-Time Client application allows you analyze the TMCC data of an ISDB-S/ARIB-compliant transport stream stored on your local disk.

The TMCC Deferred-Time client has the following characteristics:

- Indicates the presence of sync bytes (0x47 for TMCC basic streams and W1, W2, or W3 sync bytes for TMCC data streams)
- Displays the syntax of TMCC data
- Displays Slot, TSID, TS Name, and Modulation mode information
- Displays information, warning, and error messages
- Indicates the presence of TMCC alarm and update flags in the transport stream
- Displays the overall stream rate

The TMCC Deferred-Time Client displays the results of the file specified in the Input panel of the TMCC Configuration Client.

This section describes the TMCC Deferred-Time Client in the following subsections:

- *TMCC Deferred-Time Client Display Elements* page 3-112
- *Using the TMCC Deferred-Time Client* page 3-118

To start the TMCC Deferred-Time Client, select the icon from the Tektronix MPEG Test System program group window. Both the TMCC Deferred-Time Client and the TMCC Configuration Client start, and a TMCC Analysis Server icon appears in the system tray.

---

**NOTE.** *In order for the TMCC Deferred-Time Client to display analysis results, you must first specify the stream type (S\_TMCC or M\_TMCC) and rate from the TMCC Configuration Client (usually the rate is automatically detected when the TMCC Configuration Client opens the transport stream file).*

---

## Using the TMCC Deferred-Time Client Display Elements

The following figure shows the different elements of the TMCC Deferred-Time Client display.

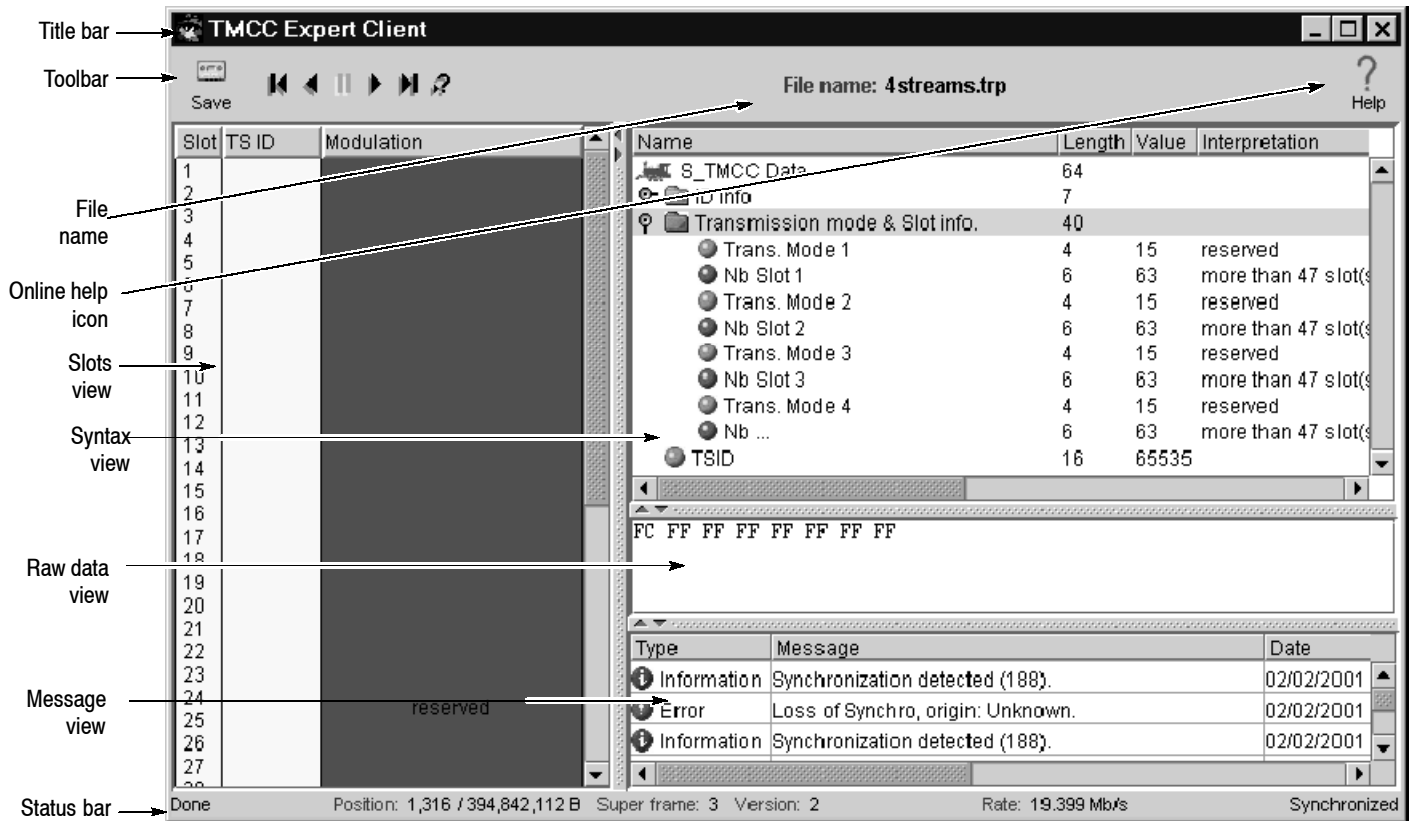







**Title Bar** The Title bar displays the name of the application (TMCC Expert Client).

The standard Windows NT window-sizing control boxes for the TMCC Deferred-Time Client are located on the far right side of the Title bar.

**Toolbar** Table 3-31 lists the function of each toolbar navigation button. The Save button allows you to save all or part of the transport stream file.

**Table 3-31: Functions of the TMCC Deferred-Time Client toolbar buttons**

Button	Name	In the Slot panel	In the Syntax panel
	First	Displays the first slot configuration	Displays the first TMCC data version
	Previous	Displays the previous slot configuration	Displays the previous TMCC data version
	Pause	Stop the analysis, returning the view to the slot configuration from which the file was played	Stops the analysis and displays the current version of TMCC data (or the version from which the analysis started)
	Next	Displays the next version of slot configuration	Displays the next TMCC data version
	Last	Displays the last version of slot configuration	Displays the last TMCC data version
	Go to	Displays the Go To dialog box from which you specify a version of the slot configuration you want to display	Displays the TMCC data version specified in the Go To dialog box

**File Name** Next to the toolbar buttons, the TMCC Deferred-Time client lists the file name of the transport stream file being analyzed. This is the file specified in the TMCC Configuration Client.

**Help Icon** Click the Help icon to access online help for the TMCC Deferred-Time Client and to identify the software version of the TMCC Deferred-Time Client.

**Slots View** The Slots view (see Figure NO TAG) displays the properties of each slot using three columns. The first column lists the slot numbers (1 through 48). The second column shows the TSID (transport stream identifier) associated with each slot.

The third column lists the modulation mode for each slot and the number of effective slots. Each modulation mode is represented by a different color (see Table 3-32).

---

**NOTE.** When the modulation mode and the number of slots are not consistent, the color of the Modulation column is red.

---

**Table 3-32: Color for each TMCC Deferred-Time Client modulation mode**

Modulation	Color
BSPK(1/2)	Dark green
QPSK(1/2)	Dark purple
QPSK(2/3)	Green
QPSK(3/4)	Mustard
QPSK(5/6)	Brown
QPSK(7/8)	Dark blue
TC8PSK(2/3)	Blue

**Syntax View**

The Syntax view (see Figure NO TAG) displays the content of the TMCC data in a hierarchic list, including the length, value, and description of the hierarchic item. Table 3-33 shows the hierarchy used for S\_TMCC and M\_TMCC streams.

Each hierarchic item is represented by a colored icon (icons are gray when the TMCC Syntax Consistency probe is not set). A green LED icon indicates that the field value is correct, a green folder icon indicates that all parameters displayed within that folder are correct. A red icon indicates that an error exists in the field value of the item or, in the case of a folder icon, in one of the subitems of a group. See Table 3-34 on page 3-116 for error conditions that cause LED icons to change color.

---

**NOTE.** For S\_TMCC streams, the Transmission frame ID and the Super frame ID fields are not updated in real-time in the TMCC Analysis Server. Their values are displayed as 0/1 in the TMCC Deferred-Time Client.

---



**Table 3-33: TMCC data syntax**

<b>S_TMCC data</b>	<b>64 bits</b>
ID info.	8 bits
Extended data	4 bits
Alarm signal	1 bit
Update indication	1 bit
Transmission frame ID	1 bit
Super frame ID	1 bit
Transmission mode & Slot info.	40 bits
Trans. mode 1	4 bits
Nb slot 1	6 bits
Trans. mode 2	4 bits
Nb slot 2	6 bits
Trans. mode 3	4 bits
Nb slot 3	6 bits
Trans. mode 4	4 bits
Nb slot 4	6 bits
TSID	16 bits
<b>M_TMCC data</b>	<b>384 bits</b>
Update indication	5 bits
Transmission mode / slot info.	40 bits
Trans. mode 1	4 bits
Nb slot 1	6 bits
Trans. mode 2	4 bits
Nb slot 2	6 bits
Trans. mode 3	4 bits
Nb slot 3	6 bits
Trans. mode 4	4 bits
Nb slot 4	6 bits
Relative TS / Slot info.	144 bits
Relative TS number slot 1 through Relative TS number slot 48	3 bits each
Relative TS / TSID	128 bits
TSID for relative TS number 0 through TSID for relative TS number 7	16 bits each
Alarm control	5 bits
Emergency alarm	1 bit
Reserved	4 bits
Extended data	62 bits
Extended flag	1 bit
Extended data	61 bits

To open or close hierarchy items in the Syntax view, click on the open/close icon to the left of the folder icon as shown below.

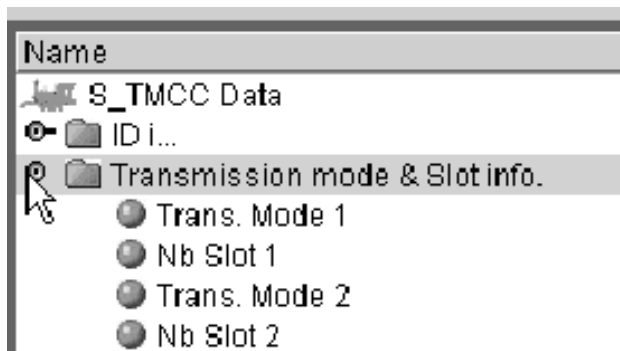

The folder and LED icons are gray when the TMCC Syntax Consistency probe is not set. When this probe is set, the folder and LED icons turn red when the conditions described in Table 3-34 are detected.

**Table 3-34: Syntax view LED icons and error conditions**

LED icon	Error condition causing an LED icon to turn red																
Trans. Mode <i>n</i>	When the transmission mode parameter is not 15 (reserved) or not one of the following values (representing transmission modes): <table border="1" style="margin-left: 20px;"> <thead> <tr> <th>Value</th> <th>Transmission mode</th> </tr> </thead> <tbody> <tr> <td>1</td> <td>BPSK (1/2)</td> </tr> <tr> <td>2</td> <td>QPSK (1/2)</td> </tr> <tr> <td>3</td> <td>QPSK (2/3)</td> </tr> <tr> <td>4</td> <td>QPSK (3/4)</td> </tr> <tr> <td>5</td> <td>QPSK (5/6)</td> </tr> <tr> <td>6</td> <td>QPSK (7/8)</td> </tr> <tr> <td>7</td> <td>TC8PSK (2/3)</td> </tr> </tbody> </table>	Value	Transmission mode	1	BPSK (1/2)	2	QPSK (1/2)	3	QPSK (2/3)	4	QPSK (3/4)	5	QPSK (5/6)	6	QPSK (7/8)	7	TC8PSK (2/3)
Value	Transmission mode																
1	BPSK (1/2)																
2	QPSK (1/2)																
3	QPSK (2/3)																
4	QPSK (3/4)																
5	QPSK (5/6)																
6	QPSK (7/8)																
7	TC8PSK (2/3)																
Nb. Slot <i>n</i>	For S_TMCC streams (TMCC basic streams), when the total number of assigned slots is greater than 47. For M_TMCC streams (TMCC data streams), when the total number of assigned slots is greater than 48. When the transmission mode parameter is 15 (reserved) and the slot parameter is not zero (0)																
Extended Data	When the Extended Flag parameter is zero (0) and all 61 bits of the Extended Data field are not one (1).																

**Raw Data View** The Raw Data view (see Figure NO TAG on page NO TAG) displays the actual hexadecimal values of the TMCC data. You can use standard Windows NT methods for selecting and copying the data to a text file.

**Message View** The Message view displays error, warning, and information messages for the TMCC analysis in progress. The messages include the message type (error, warning, and information), the message content, and the time of the message. The maximum number of displayed messages is 1000. Additional messages are handled on a first in first out basis.

You can right-click in the Message view to open the dialog box shown below where you can sort and clear messages. You can also use the dialog box to change the number of lines allowed for each message so that you can view the complete content of multiple-line messages.

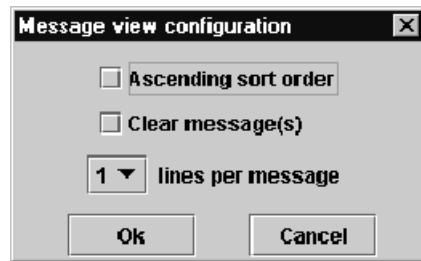

---

**NOTE.** Some messages are too long to be displayed in three lines; double-click the message to display a pop-up message window with the full message text.

---

**Status Bar** The Status bar displays the following information (reading from left to right):

- The status of the analysis (Done, Idle, or Analyzing)
- The position and total number of bytes in the bit stream
- The super frame number and version of slot configuration
- The stream rate
- The synchronization status

## Using the TMCC Deferred-Time Client

This section provides several common procedures for using the TMCC Deferred-Time Client:

- *Starting the TMCC Deferred-Time Client* page 3-118
- *Specifying a TMCC Transport Stream File* page 3-119
- *Displaying Slot Configurations* page 3-121
- *Displaying Syntax Information* page 3-122
- *Displaying Messages* page 3-124
- *Saving Transport Stream Files* page 3-125
- *Setting Probes* page 3-121
- *Saving and Applying Configurations* page 3-126

After this section, the probes you can set using the TMCC Configuration Client are described (see page 3-128).

### Starting the TMCC Deferred-Time Client

To start the TMCC Deferred-Time Client, double-click the icon in the Tektronix MPEG Test System program group window, or select the application from the Start | Programs | Tektronix MPEG Test System group.

When you start the TMCC Deferred-Time Client, the TMCC Configuration Client is also started showing the last configuration.

---

**NOTE.** *In order for the TMCC Deferred-Time Client to display analysis results, you must first specify the stream type (S\_TMCC or M\_TMCC) and rate from the TMCC Configuration Client (usually the rate is automatically detected when the TMCC Configuration Client opens the transport stream file).*

---

## Specifying a TMCC Transport Stream File

Use these steps to specify the TMCC transport stream file you will analyze:

1. Display the TMCC Configuration Client (with the TMCC Deferred-Time Client is also started), and then select Input from the Navigation frame.

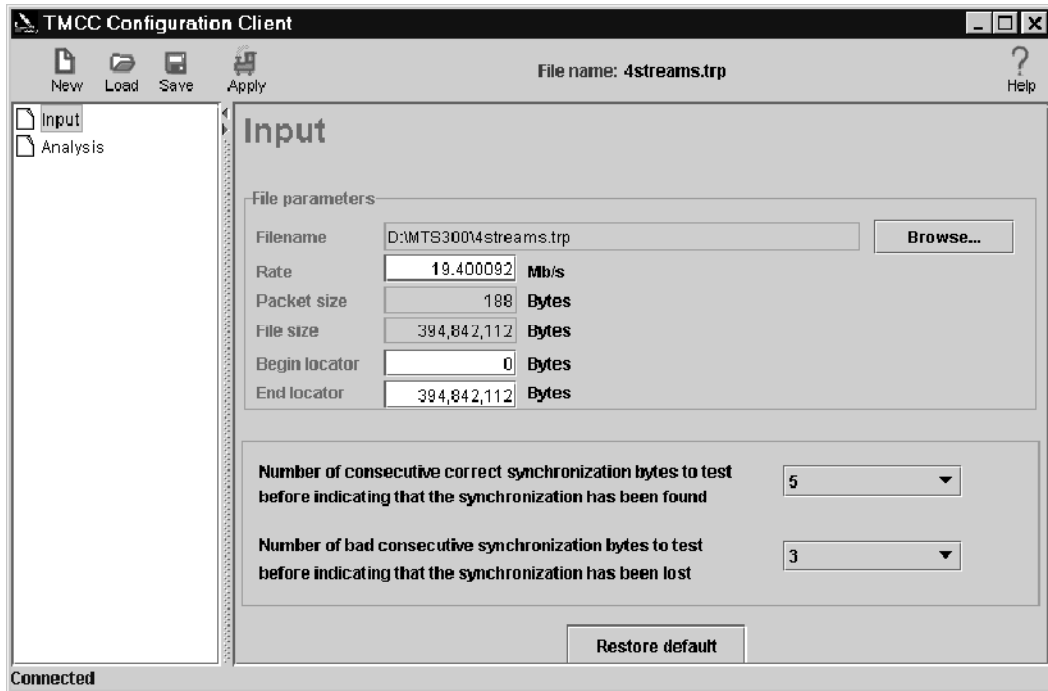

2. Click the Browse button and select a local \*.trp file, and then return to the TMCC Configuration Client.
3. Update the Rate, if necessary (usually the rate is updated automatically). The rate is calculated from the PCRs in the streams and is given in Mbps.
4. Select the part of the file you want to analyze using the Begin locator and End locator text boxes. The default for these two values is the beginning and end of the file.
5. If necessary, select the appropriate number of sync bytes to test for sync and loss of sync.

6. Click Analysis in the Navigation frame to display the Analysis panel.

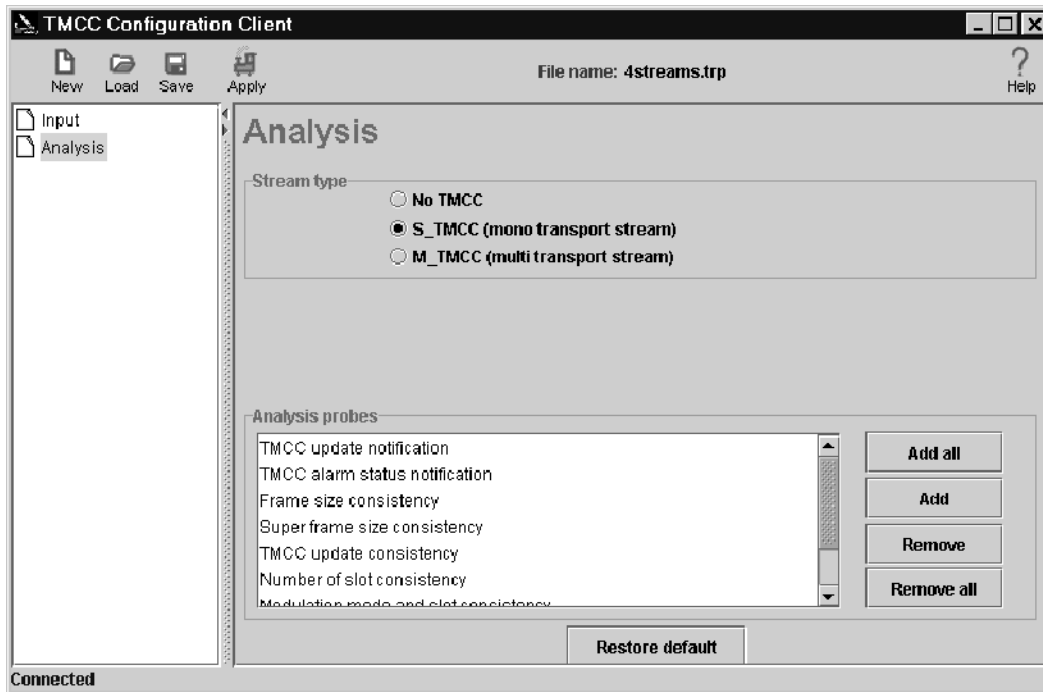

7. Select the appropriate stream type from among the options provided:
  - No TMCC to analyze a TMCC streams without looking at the TMCC data (for instance, you may simply want to see the reported rate in the TMCC Deferred-Time Client).
  - S\_TMCC to analyze a single transport stream multiplex (a TMCC basic stream)
  - M\_TMCC to analyze a multiple transport stream multiplex (a TMCC data stream)
8. Click **Apply** to apply your settings to the TMCC Analysis Server, or set some probes first using the procedure described in *Setting Probes* on page 3-121.

**Setting Probes**

Use these steps to set the probes used to analyze the transport stream file specified in the Input panel of the TMCC Configuration Client:

1. Display the TMCC Configuration Client (with the TMCC Deferred-Time Client is also started), and then select Analysis from the Navigation frame.
2. Click Add or Add All from the Analysis Probes area.

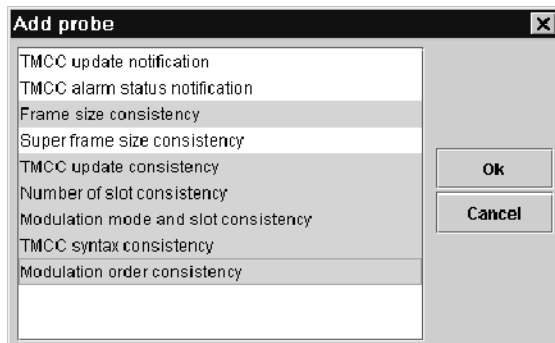

3. Select the probes you want to add and click **OK**.
4. Click the Apply button on the toolbar.







**Displaying Slot Configurations**

Use the TMCC Deferred-Time Client toolbar buttons to display different versions of slot configurations encoded in the transport stream file listed in the File name area.

Button	Name	In the Slot panel
	First	Displays the first slot configuration
	Previous	Displays the previous slot configuration
	Pause	Stop the analysis, returning the view to the slot configuration from which the file was played
	Next	Displays the next version of slot configuration
	Last	Displays the last version of slot configuration
	Go to	Displays the Go To dialog box from which you specify a version of the slot configuration you want to display

### Displaying Syntax Information

Use the TMCC Deferred-Time Client toolbar buttons to display different versions of slot configurations encoded in the transport stream file listed in the File name area. The Syntax panel displays the syntax of the version indicated in the status bar.

Button	Name	In the Syntax panel
	First	Displays the first TMCC data version
	Previous	Displays the previous TMCC data version
	Pause	Stops the analysis and displays the current version of TMCC data (or the version from which the analysis started)
	Next	Displays the next TMCC data version
	Last	Displays the last TMCC data version
	Go to	Displays the TMCC data version specified in the Go To dialog box

To open or close hierarchy items in the Syntax view, click on the open/close icon to the left of the folder icon as shown below.

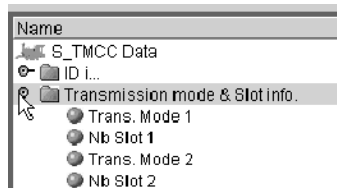



The folder and LED icons are gray when the TMCC Syntax Consistency probe is not set. When this probe is set, the folder and LED icons turn red when the conditions described in following listing are detected.

LED icon	Error condition causing an LED icon to turn red																
Trans. Mode <i>n</i>	<p>When the transmission mode parameter is not 15 (reserved) or not one of the following values (representing transmission modes):</p> <table border="1"> <thead> <tr> <th>Value</th> <th>Transmission mode</th> </tr> </thead> <tbody> <tr> <td>1</td> <td>BPSK (1/2)</td> </tr> <tr> <td>2</td> <td>QPSK (1/2)</td> </tr> <tr> <td>3</td> <td>QPSK (2/3)</td> </tr> <tr> <td>4</td> <td>QPSK (3/4)</td> </tr> <tr> <td>5</td> <td>QPSK (5/6)</td> </tr> <tr> <td>6</td> <td>QPSK (7/8)</td> </tr> <tr> <td>7</td> <td>TC8PSK (2/3)</td> </tr> </tbody> </table>	Value	Transmission mode	1	BPSK (1/2)	2	QPSK (1/2)	3	QPSK (2/3)	4	QPSK (3/4)	5	QPSK (5/6)	6	QPSK (7/8)	7	TC8PSK (2/3)
Value	Transmission mode																
1	BPSK (1/2)																
2	QPSK (1/2)																
3	QPSK (2/3)																
4	QPSK (3/4)																
5	QPSK (5/6)																
6	QPSK (7/8)																
7	TC8PSK (2/3)																
Nb. Slot <i>n</i>	<p>For S_TMCC streams (TMCC basic streams), when the total number of assigned slots is greater than 47.</p> <p>For M_TMCC streams (TMCC data streams), when the total number of assigned slots is greater than 48.</p> <p>When the transmission mode parameter is 15 (reserved) and the slot parameter is not zero (0)</p>																
Extended Data	When the Extended Flag parameter is zero (0) and all 61 bits of the Extended Data field are not one (1).																

### Displaying Messages

The Message view displays error, warning, and information messages for the TMCC analysis in progress. The messages include the message type (error, warning, and information), the message content, and the time of the message. The maximum number of displayed messages is 1000. Additional messages are handled on a first in first out basis.

You can right-click in the Message view to open the dialog box shown below where you can sort and clear messages. You can also use the dialog box to change the number of lines allowed for each message so that you can view the complete content of multiple-line messages.

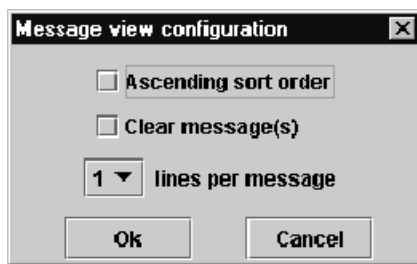

---

**NOTE.** Some messages are too long to be displayed in three lines; double-click the message to display a pop-up message window with the full message text.

---

## Saving Transport Stream Files

Use these steps to save part or all of the transport stream file you are analyzing to a local file:

1. Click the Save toolbar button in the TMCC Deferred-Time Client.

---

**NOTE.** *Transport stream files can be large. Ensure that the location you are saving the file to has enough disk space and that you have write permissions.*

---

2. In the Save dialog box, browse to a location on your local disk where you will save the file and give the file a name.

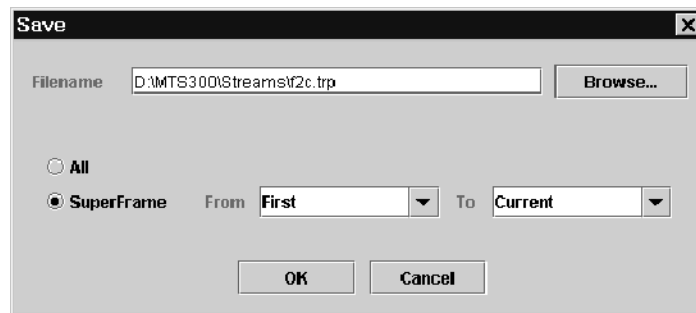

3. Select **All** or **SuperFrame**.
4. If you select **SuperFrame**, you can choose from among the following choices for both the **From** and **To** combination boxes:
  - First
  - Current
  - Last

You can also enter specific super frames in the **From** and **To** combination boxes.

5. Click **OK**.

### Saving and Applying Configurations

The toolbar buttons of the TMCC Configuration Client allow you to perform the following functions:





- Save all of the current TMCC analysis configuration settings to a file
- Load a saved TMCC analysis configuration file
- Restore the standard, factory-default TMCC analysis configuration
- Apply any configuration setting changes to the TMCC Analysis Server

---

**NOTE.** You must click the Apply toolbar button before your configuration changes will be applied to the TMCC Analysis Server input.

---

**Table 3-35: Functions of the TMCC Configuration Client Toolbar buttons**

Button	Name	Function
	New configuration (CTRL+N)	Loads the default TMCC analysis settings into each of the configuration panels in the TMCC Configuration Client (stream type of No TMCC, and no TMCC probes set).
	Load configuration (CTRL+L)	Loads a previously saved set of analysis settings into each of the configuration panels in the TMCC Configuration Client. A dialog box is displayed from which you select a previously saved TMCC configuration file.
	Save configuration (CTRL+S)	Saves the current TMCC analysis settings to a file. A dialog box appears where you can enter a path and file name.  It is recommended that you save the TMCC configurations in the following directory on the MTS300 system: c:\MTS300\CFG-TRP.
	Apply (CTRL+A)	Applies the current TMCC analysis settings to the TMCC Analysis Server indicated in the address bar.

**Saving the Current Configuration.** To save the current TMCC analysis configuration , perform the following procedure:

1. Click the **Save** toolbar button to open the Save window.
2. Use the Save window to save the current TMCC analysis settings to a file on the hard drive of the MTS300 system.

It is recommended that you save TMCC analysis configurations in the following directory on the MTS300 system: C:\MTS300\CFG-TRP.

**Restoring the Default Configuration.** To restore the default TMCC Analysis Server configuration, click the **New** toolbar button, and then click the **Apply** toolbar button. All TMCC analysis settings will now be restored to the factory-default state (stream type of No TMCC, and no TMCC probes set).

**Loading a Saved Configuration.** To restore a TMCC Analysis Server configuration that has been saved on the hard drive of the MTS300 system, perform the following procedure:

1. Click the **Load** toolbar button to open the **Load Configuration** window.
2. Highlight the name of the configuration file that you want to restore, and then click **Load**.
3. Click the **Apply** toolbar button to apply the configuration changes to the TMCC Analysis Server.

**Deleting a Saved Configuration.** Use Windows NT Explorer to locate and delete a saved TMCC Analysis Server configuration file on the hard drive of the MTS300 system. The file name will have a .CNF extension.

## TMCC Probe Descriptions

You can use the new TMCC analysis capabilities of the MTS300 system to set TMCC analysis probes for the file indicated in the Input panel of the TMCC Configuration Client. Probes are set from the Analysis panel of the TMCC Configuration Client, analysis results are displayed in the TMCC Deferred-Time Client. This section describes these probes. See the *TMCC Deferred Time Client* and the *TMCC Configuration Client* sections for information about using those clients.

The TMCC Configuration Client allows you to set the following TMCC probes (page numbers indicate the page on which the probe is described):

- *TMCC Update Notification Probe* page 3-128
- *TMCC Alarm Status Notification Probe* page 3-129
- *Frame Size Consistency Probe* page 3-129
- *Super Frame Size Consistency Probe* page 3-129
- *TMCC Update Consistency Probe* page 3-129
- *Number of Slots Consistency Probe* page 3-130
- *Modulation Mode and Slot Consistency Probe* page 3-130
- *TMCC Syntax Consistency Probe* page 3-130
- *Modulation Order Consistency Probe* page 3-131

The TMCC files being analyzed are always checked for the following characteristics (the results are displayed in the Status bar of the TMCC Deferred-Time Client):

- Synchronization bytes
  - 0x47 for single-transport stream multiplexes
  - W1 (0x1B95), W2 (0xA340), and W3 (0x5CBF) for multiple-transport stream multiplexes
- Overall TMCC stream rate

Set the stream rate in the TMCC Configuration Client.

### **TMCC Update Notification Probe**

**Error Condition:** A message is generated when at least one bit is modified in the TMCC information. The `transmission_frame_id` and `super_frame_id` fields are not analyzed for this probe.

**How/Where and alarm is displayed:** This is reported as an information message in the Messages panel of the TMCC Deferred-Time Client.

<b>TMCC Alarm Status Notification Probe</b>	<p><b>Error Condition:</b> A message is generated when either the <code>alarm_signal_flag</code> or the <code>emergency_alarm_flag</code> fields are set to 1.</p> <p><b>How/Where and alarm is displayed:</b> This is reported as an information message in the Messages panel of the TMCC Deferred-Time Client.</p>
<b>Frame Size Consistency Probe</b>	<p><b>Error Condition:</b> The following statements must be true, or an error is generated by the TMCC Analysis Server:</p> <ul style="list-style-type: none"><li>■ The current computed frame size is the same as the latest frame size.</li><li>■ The computed frame size is equal to the total number of slots indicated in the <code>transmission_mode</code> and <code>slot_info</code> fields.</li></ul> <p><b>How/Where and alarm is displayed:</b> This error is reported as an ISDB multiplex error in the Master Client and as an error message in the Message panel of the TMCC Deferred-Time Client.</p>
<b>Super Frame Size Consistency Probe</b>	<p><b>Error Condition:</b> The following statements must be true, or an error is generated by the TMCC Analysis Server:</p> <ul style="list-style-type: none"><li>■ The super frame size is eight (8).</li><li>■ If the <code>transmission_frame_id</code> is one (1), the <code>super_frame_id</code> must also be one (1). This ensures that the first frame of the super frame is synchronized with the first frame.</li></ul> <p><b>How/Where and alarm is displayed:</b> This error is reported as an ISDB multiplex error in the Master Client and as an error message in the Message panel of the TMCC Deferred-Time Client.</p>
<b>TMCC Update Consistency Probe</b>	<p><b>Error Condition:</b> The following statements must be true, or an error is generated by the TMCC Analysis Server:</p> <ul style="list-style-type: none"><li>■ When the TMCC information is updated, the following statements are also true:<ul style="list-style-type: none"><li>■ The <code>update_indication</code> flag is one (1).</li><li>■ The <code>update_indication</code> counter is correctly incremented.</li></ul></li></ul> <p><b>How/Where and alarm is displayed:</b> This error is reported as an ISDB multiplex error in the Master Client and as an error message in the Message panel of the TMCC Deferred-Time Client.</p>

**Number of Slots Consistency Probe**

**Error Condition:** The following statements must be true, or an error is generated by the TMCC Analysis Server:

- For TMCC basic streams, the number of slots must be less than 48
- For TMCC data streams, the number of slots must be 48

**How/Where and alarm is displayed:** This error is reported as an ISDB multiplex error in the Master Client, as an error message in the Message panel of the TMCC Deferred-Time Client, and the modulation scheme color becomes red in the Slots panel of the TMCC Deferred-Time Client.

**Modulation Mode and Slot Consistency Probe**

**Error Condition:** The following statement must be true, or an error is generated by the TMCC Analysis Server:

- The minimum number of slots is not consistent with the modulation mode. The number of packets transmitted and the number of symbols used for a given modulation scheme is given by the following equation:

$$I_k = \frac{8 \times B \times P_k}{E_k}$$

Where:

- $I_k$  is the integer number of symbols transmitted with the k-th combination of the modulation scheme and inner code rate
- $P_k$  is the integer number of packets transmitted with the k-th combination of the modulation scheme and inner code rate
- $E_k$  is the spectrum efficiency of the k-th combination of the modulation scheme and inner code rate
- $B$  is 204, the number of bytes per packet

**How/Where and alarm is displayed:** This error is reported as an ISDB multiplex error in the Master Client, as an error message in the Message panel of the TMCC Deferred-Time Client, and the modulation scheme color becomes red in the Slots panel of the TMCC Deferred-Time Client.

**TMCC Syntax Consistency Probe**

**Error Condition:** If the syntax of TMCC fields is incorrect, an error is generated by the TMCC Analysis Server.

**How/Where and alarm is displayed:** This error is reported as an ISDB multiplex error in the Master Client, as a red icon in the Syntax view of the TMCC Deferred-Time Client, and as an error message in the Message panel of the TMCC Deferred-Time Client.



**Modulation Order  
Consistency Probe**

**Error Condition:** If the order of the different modulation schemes used in the transport stream is incorrect, an error is generated by the TMCC Analysis Server. (The highest efficiency modulation scheme used in the transport stream must use the lower numbered slots, and the lower efficiency modulation schemes used must use the higher numbered slots.)

**How/Where and alarm is displayed:** This error is reported as an ISDB multiplex error in the Master Client, as an error message in the Message panel of the TMCC Deferred-Time Client, and the modulation scheme color becomes red in the Slots panel of the TMCC Deferred-Time Client.





# Appendices



# Appendix A: What to Do if an Application Locks Up

In the event an application locks up or freezes, perform the following steps to close the application.

1. Try closing the application with the Windows NT Security dialog box as follows:
  - a. Press **Ctrl+Alt+Del** to open the Windows NT Security dialog box.
  - b. Click the **Task Manager** button to open the Windows NT Task Manager.
  - c. Highlight the locked-up application.
  - d. Click the **End Task** button.

In some circumstances, a window opens prompting you to wait, end the task, or cancel your “end task” instruction. Follow the window instructions; if you click End Task, the application should close immediately.

- e. If the above procedure fails to close the application, press **Ctrl+Alt+Del** again to return to the Windows NT Security dialog box.
  - f. Click the **Shut Down** button. This opens the Shutdown Computer dialog box.
  - g. Select the **Shutdown and Restart** option button; then click **OK**.
2. If the above procedures do not close the application or restart the computer, manually power off the computer; then proceed with a normal power on.



---

**CAUTION.** *To avoid data loss, do not power off the computer without first exiting Windows NT. Use the manual reset only if the computer does not respond.*

---

To ensure that all parameters are reset, perform a complete power cycle following an application lock up.



## Appendix B: Software Repair

Use the procedures in this section to uninstall and reload the test system software if the installed copy is corrupted. See the *MTS300 MPEG Test System Hardware and Software Installation Technical Reference* (Tektronix part number, 071-0667-XX) for information about rebuilding the operating system for the MTS300 test system.

### Reinstalling the MTS300 Software

Use the procedures below to reinstall MTS300 test system applications accidentally deleted or corrupt. Software is supplied on the CD ROM shipped with your product or upgrade.

---

**NOTE.** *The following instructions are for reinstalling MPEG Test System software on a machine running Windows NT Workstation 4.0 only; procedures for upgrading your software could be different. If you are installing a software upgrade, follow the instructions provided with the upgrade kit.*

---

Reinstalling the software involves three procedures:

- Uninstalling the current software
- Installing the software
- Entering passwords for licensed applications

---

**NOTE.** *In some cases, you may need to install the Java run-time environment; for instance, if your license includes the TMCC Deferred-Time Analyzer. If you are prompted to install the Java run-time environment before installing the software, run the executable file in the jre directory of the Application CD.*

---

### Uninstalling Software

Remove the existing software using the unInstallShield application.

1. Restart Windows NT and log on as the administrator (Username = administrator; password = MPEG2). You must log on as the administrator to install MTS300 applications.
2. Quit any applications that automatically started at login.
3. Double-click the **Uninstall MTS3...** icon in the Tektronix MPEG Test System program group window.
4. When the dialog box asks you to confirm the file deletion, click **Yes**.
5. When uninstall is complete, Click **OK** to close the Remove Programs From Your Computer window.

### Installing Software

1. If you are not already logged on, log onto your NT workstation as Administrator.
2. Right-click the **My Computer** icon on your Windows NT desktop, and then select **Explore** from the submenu. In the Exploring window, select the icon that represents the disk drive onto which you will install the software (usually drive C:).
3. Check the status bar at the bottom of the Exploring window to verify that the target disk has at least 140 MB of free space. You cannot install the software on a disk that has less than 140 MB of free space.

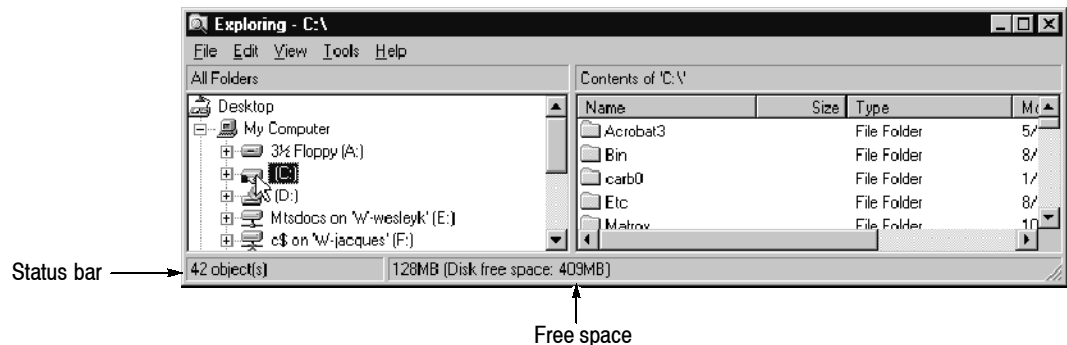

4. Place the MPEG Test System Version 6.0 Installation Software CD ROM into the CD ROM drive.
5. Click the Windows NT Start button, and then select **Run**.
6. Enter d:\Setup.exe in the resulting Run window as depicted in the following illustration (in this example, *d* is the drive letter for the CD ROM drive; use the drive letter that is correct for your computer), and then click **OK**.



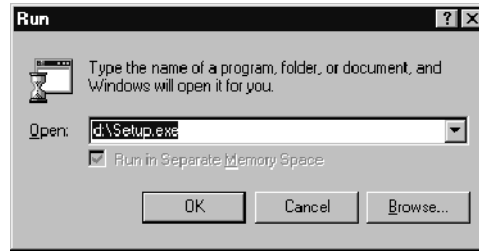

7. In a few seconds, the Tektronix MTS300 Series window appears on the computer screen.
8. Read the Copyright and Setup text and then click **Next** to proceed to the Choose Destination Directory window.

---

**NOTE.** *It is strongly recommended that you use the default destination folder.*

---

9. The default destination folder is C:\Mts300. Click **Next** to accept the default folder.
10. The Setup Type window opens.
  - If you are installing the software on a machine that has no MPEG Test System hardware, select **MTS300 Software Only**.

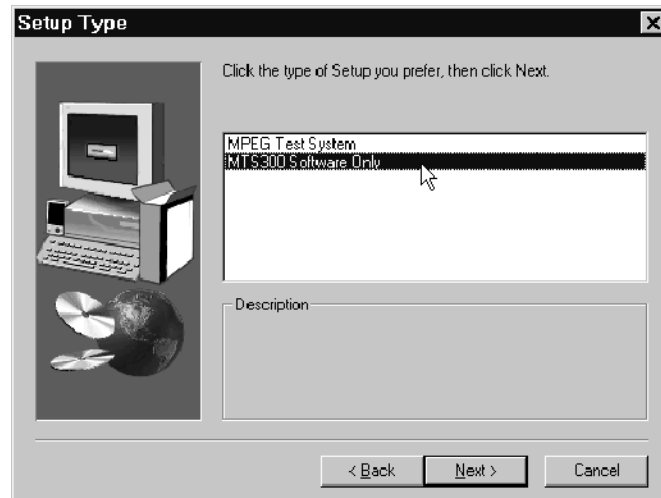

- If you are installing software onto an MPEG Test System, select **MPEG Test System** and continue with the procedure as described in the *MTS300 MPEG Test System Hardware and Software Installation Technical Reference* that accompanied the test system.

11. Click **Next** in the Select Program Folder window to accept the default folder name (Tektronix MPEG Test System) and continue.
12. Review the Destination Directory, Selection, and Start Menu Folder selections in the Selection Summary window. If the selections are incorrect, click **Back** and change the information as needed. Once the information is correct, click **Next** to proceed with installation.

The setup program begins installing the software and related sample files. The activity and progress gauges appear at first to show that installation is progressing.

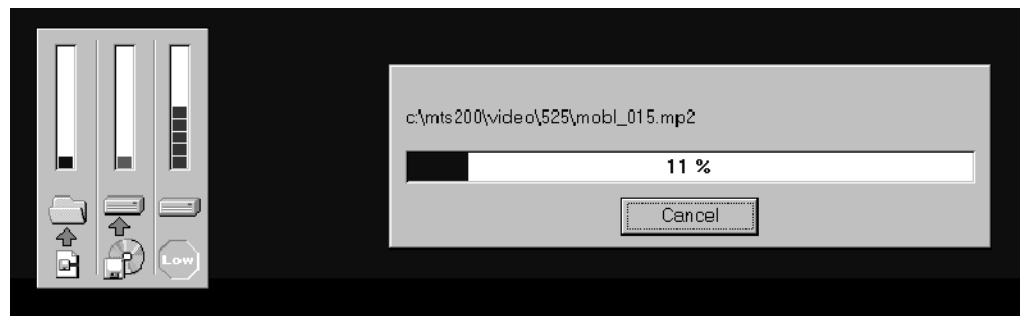

Installation proceeds without your input (and sometimes with no apparent activity) for approximately two minutes, depending on your computer platform.

During a normal setup, two empty program group windows are displayed after the program files have been copied to your disk drive. Shortly after these windows appear, a message reminds you to verify that the Dongle (software key) is installed.

13. Ensure that the software key is installed on the parallel printer port as described in *Software Key* on page 1-1, and then click **OK**.
14. The Setup Complete window opens; click **Finish** to continue.
15. A Notepad window opens to display the Readme file. Read this file for important information, and then exit Notepad.
16. Another Setup Complete window opens. Accept the *Yes, I want to restart my computer now* option, remove the MPEG Test System disc from the CD ROM drive, and click **Finish** to complete setup and reboot the system.

---

**NOTE.** *You need to restart your computer before you enter the license password in the next procedure.*

---

17. When prompted, log on as any user.
18. If not already displayed, open the Tektronix MPEG Test System program group window by double-clicking the folder icon on the desktop.



The program group window resembles the following illustration.

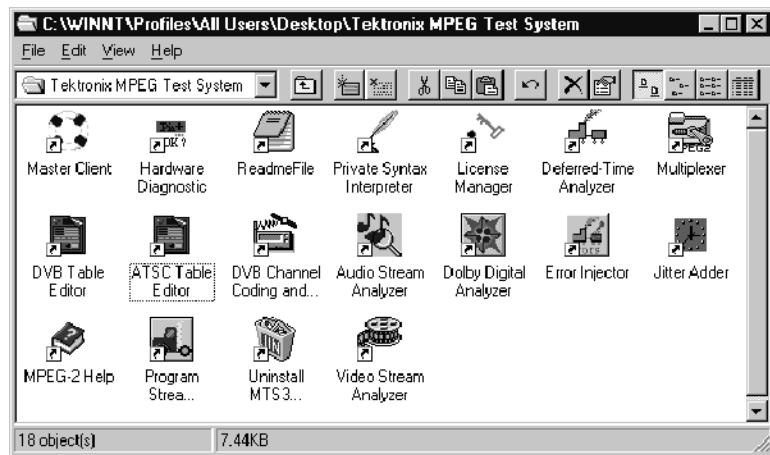

## Entering the General License Password



Perform the remaining steps to enter the general password that corresponds to the attached software key. Doing so enables the applications that are included with your MTS300 MPEG Test System product.

1. Double-click the **License Manager** icon in the Tektronix MPEG Test System program group window to start the Tektronix Software Protection application.

The Tektronix Software Protection window appears.



2. Consult the password document supplied with your software and identify the general password.
3. Enter the three 6-character hexadecimal numbers of the password in the corresponding Tektronix Software Protection window entry fields (lowercase characters are acceptable).
4. Click **OK**. A License message window appears.
5. If the password is correct, click **OK** to acknowledge the message. If you made an error entering the password, click **OK** and return to step 2.

When you enter the correct password, software installation is complete. You will need to restart the computer before you can start any of the stream creation applications.

# Appendix C: Analyzer Tests

This section describes bitstream tests performed by the Deferred-Time Analyzer application, version 5.02.02 and above.

---

**NOTE.** *This appendix does not include tests added to MTS300 software version 2.0 and up.*

---

The tests shown in normal typeface can be found in the compliance document (ISO/IEC 13818-4 DIS).

The tests shown in italics are not described in the compliance document, or are described but are erroneous and/or incomplete.

All the fields are indicated, even those for which no tests are performed. The fields are listed exactly in the same order as given in the Standard (ISO/IEC 13818-1 IS of 13 November 1994).

## Compliance at the Transport Stream Level

There are two parts at this level: the Transport Packet Header and the Adaptation Field.

**Table C-1: Compliance for the Transport Packet Header**

Parameter	Error checking
<b>sync_byte</b> (sb):	test that (sb == 0x47)
<b>transport_error_indicator</b> (tei):	test that (tei != 1)
<b>payload_unit_start_indicator</b> (pusi):	<i>if</i> (pid == 0x1FFF) <i>then</i> test that (pusi == '0')
<b>transport_priority</b> (tp):	no test
<b>PID</b> (pid):	<ol style="list-style-type: none"> <li>test that pid is in [0x0000, 0x0001, 0x0010 .. 0x1FFF]</li> <li>issue a warning if pid emulates 0x47</li> <li>verify that there is at least one packet with pid == 0x0000 in the stream</li> </ol>
<b>transport_scrambling_control</b> (tsc):	<ol style="list-style-type: none"> <li><i>if</i> (pid == 0x0000 or 0x0001 or 0x1FFF) <i>then</i> test that (tsc == '00')</li> <li><i>if</i> (pid == PID_PMT) <i>then</i> test that (tsc == '00')</li> </ol>
<b>NOTE:</b> <i>the PID_PMTs are given by the program_map_PID fields in the PAT sections.</i>	

Table C-1: Compliance for the Transport Packet Header (Cont.)

Parameter	Error checking
<b>adaptation_field_control</b> (afc):	<p><u>if</u> (pid == 0x1FFF)  <u>then</u> test that (afc == '01')  <u>else</u> test that (afc != '00')</p>
<b>continuity_counter</b> (cc):	<p><u>if</u> (afc in == 'x1')  <u>and</u> ((AF.di == '0') or (afc == '0x'))  <u>and</u> (pid != 0x1FFF)  <u>and</u> packet is not a duplicate  <u>then</u> test that (cc == previous_cc + 1, modulo 16)</p> <p><b>NOTE:</b> <i>previous_cc means value of the continuity_counter of the previous TS packet with the same PID.</i></p>
<b>data_byte</b> (db):	<ol style="list-style-type: none"> <li>1. <u>if</u> (pusi == '1')  <u>and</u> (pid == PID_PES)  <u>and</u> (tsc == '00') or stream has been unscrambled  <u>then</u> test that db starts with 0x000001 followed by the correct sid</li> <li>2. <u>if</u> (pusi == '0')  <u>and</u> (pid == PID_PES)  <u>and</u> (tsc == '00') or stream has been unscrambled  <u>then</u> test that db does not contain 0x000001 followed by the correct sid</li> <li>3. <u>if</u> (pusi == '1')  <u>and</u> (pid == PID_PSI)  <u>and</u> (tsc == '00') or stream has been unscrambled  <u>then</u> test that db starts with pointer field to the correct table_id</li> <li>4. <u>if</u> packet is not a duplicate  <u>and</u> (previous_AFH.sc == 0)  <u>and</u> (tsc == '00') or stream has been unscrambled  <u>then</u> test that db starts with 0x000001 followed by the correct sid</li> </ol> <p><b>NOTE:</b></p> <ol style="list-style-type: none"> <li>1. <i>PID_PES are given by the elementary_PID fields given in the PMT sections.</i></li> <li>2. <i>PID_PSI are 0x0000 for PAT, 0x0001 for CAT, the PIDs given by the program_map_PID fields in the PAT sections, PID given by the network_PID field in the PAT sections.</i></li> <li>3. <i>correct table_id are 0x00 for PAT, 0x01 for CAT, 0x02 for PMT and [0x40 .. 0xFE] for NIT.</i></li> <li>4. <i>correct sid means '1110 xxxx' for video and '110x xxxx' for audio.</i></li> <li>5. <i>previous_AFH.sc means the value of the splice_countdown field of the previous TS packet with the same PID (duplicate packets and packets with no payload excluded).</i></li> </ol>

**Special Tests in the Case of a Duplicate Packet**

The following test should be used to determine whether a packet is a duplicate packet:

```

if (afc == 'x1')
and (AF.di == '0') or not present
and (pid != 0x1FFF)
and (cc == previous_cc)
then packet is a duplicate

```

For a duplicate packet, you should verify that the previous packet with the same PID is not a duplicate packet.

**Table C-2: Compliance for the Adaptation Field (AF)**

Parameter	Error checking
adaptation_field_length (afl):	<ol style="list-style-type: none"> <li>if (TPH.afc == '10') then test that (afl == 183)</li> <li>if (TPH.afc == '11') then test that afl is in [0 .. 182]</li> </ol>
discontinuity_indicator (di):	no test
random_access_indicator (rai):	no test
elementary_stream_priority_indicator (espi):	no test
PCR_flag (pcrf):	<ol style="list-style-type: none"> <li>if (opcrf == '1') then test that (pcrf == '1')</li> <li>if (rai == '1') and (TPH.pid == PID_PCR) then test that (pcrf == '1')</li> </ol> <p><b>NOTE:</b> the PID_PCR are the PIDs given by the PCR_PID fields in the PMT sections.</p>
OPCR_flag (opcrf):	no test
splicing_point_flag (spf):	if packet is not duplicate and (TPH.afc == '11') and (previous_spf == 1) and (previous_sc != 0) then test that (spf == 1)
transport_private_data_flag (tpdf):	no test
adaptation_field_extension_flag (afef):	if packet is not duplicate and (TPH.afc == '11') and (previous_afef == 1) and (previous_sc != 0) then test that (afef == 1)
program_clock_reference_base (pcrb):	no test
reserved (r1):	test that (r1 == '111111')
program_clock_reference_extension (pcre):	no test

Table C-2: Compliance for the Adaptation Field (AF) (Cont.)

Parameter	Error checking
<b>original_program_clock_reference_base</b> (opcrb):	no test
<b>reserved</b> (r2):	test that (r2 == '111111')
<b>original_program_clock_reference_extension</b> (opcre):	no test
<b>splice_countdown</b> (sc):	<p><u>if</u> (packet is not duplicate)  <u>and</u> (TPH.afc == '11')  <u>then</u> test that (sc == previous_sc - 1)</p> <p><b>NOTE:</b> previous_sc is the value of sc in the previous packet of the same PID (duplicate packets and packets with no payload excluded).</p>
<b>transport_private_data_length</b> (tpdl):	<ol style="list-style-type: none"> <li>test that (tpdl &gt; 0)</li> <li>test that (tpdl &lt; afl - compute_length())</li> </ol> <p>compute_length is the following function:</p> <pre>int compute_length() {     int length = 1     if (pcrf == '1') then length += 6     if (opcrf == '1') then length += 6     if (spf == '1') then length++     if (afef == '1') then length += afel }</pre>
<b>private_data_byte</b> (pdb):	no test
<b>adaptation_field_extension_length</b> (afel):	test that (afel > 0)
<b>ltw_flag</b> (lf):	no test
<b>piecewise_rate_flag</b> (prf):	no test
<b>seamless_splice_flag</b> (ssf):	<p><u>if</u> packet is not duplicate  <u>and</u> (TPH.afc == '11')  <u>and</u> (previous_ssf == 1)  <u>and</u> (previous_sc != 0)  <u>then</u> test that (ssf == 1)</p>
<b>reserved</b> (r3):	test that (r3 == '11111')
<b>ltw_valid_flag</b> (lvf):	no test
<b>ltw_offset</b> (lo):	no test
<b>reserved</b> (r4):	test that (r4 == '11111111')
<b>piecewise_rate</b> (pr):	no test



Table C-2: Compliance for the Adaptation Field (AF) (Cont.)

Parameter	Error checking
<b>splice_type</b> (st):	<ol style="list-style-type: none"> <li>1. <u>if</u> (packet carries audio stream) <u>then</u> test that (st == '0000')</li> <li>2. <u>if</u> (packet carries video stream) <u>then</u> test that st is not in ['0100' .. '1011']</li> <li>3. <u>if</u> (not first occurrence of st) <u>and</u> (previous_sc != 0) <u>then</u> test that (st == previous_st)</li> </ol> <p><b>NOTE:</b></p> <ol style="list-style-type: none"> <li>1. for a definition of previous_sc, see note 1 of sc.</li> <li>2. previous_st means the value of st in the previous packet with the same PID (duplicate packets or packets without payload excluded).</li> <li>3. the information about the type of stream (audio or video) can be found in the stream_type fields of the PMT sections.</li> </ol>
<b>DTS_next_au</b> (dtsna):	<u>if</u> (not first occurrence of dtsna) <u>and</u> (previous_sc != 0) <u>then</u> test that (dtsna == previous_dtsna) <p><b>NOTE:</b></p> <ol style="list-style-type: none"> <li>1. for a definition of previous_sc, see note 1 of sc.</li> <li>2. previous_dtsna means the value of dtsna in the previous packet with the same PID (duplicate packets or packets without payload excluded).</li> </ol>
<b>marker_bit</b> (mb):	test that (mb == '1') for all mb in the packet
<b>reserved</b> (r5):	test that (r5 == '1111 1111') for all bytes
<b>stuffing_byte</b> (sb):	test that (sb == '1111 1111') for all bytes

## Compliance at the PES Packet Level

The following tests should be performed only if the transport\_scrambling\_control field of the transport packets is equal to '00' or the PES stream has been unscrambled.

**Table C-3: Compliance for the PES packet header**

Parameter	Error checking
<b>packet_start_code_prefix</b> (pscp):	test that (pscp == 0x000001)
<b>stream_id</b> (sid):	<ol style="list-style-type: none"> <li>1. sid != a reserved value</li> <li>2. sid &gt;= 0xBC</li> <li>3. test that each PES packet carried in the TS packets of the same PID value have the same sid</li> <li>4. <u>if</u> (packet carries audio) <u>then</u> test that sid is in [0xC0 .. 0xDF]</li> <li>5. <u>if</u> (packet carries video) <u>then</u> test that sid is in [0xE0 .. 0xEF]</li> </ol>
<b>PES_packet_length</b> (pespl):	if sid indicates that packet does not carry video then test that (pespl != 0)
'10':	test that these two bits are really equal to '10'
<b>PES_scrambling_control</b> (pessc):	no test
<b>PES_priority</b> (pesp):	no test
<b>data_alignment_indicator</b> (dai):	no test
<b>copyright</b> (©):	no test
<b>original_or_copy</b> (ooc):	no test
<b>PTS_DTS_flags</b> (ptsdtsf):	test that (ptsdtsf != '01')
<b>ESCR_flag</b> (escrf):	no test
<b>ES_rate_flag</b> (esrf):	no test
<b>DSM_trick_mode_flag</b> (dsmtmf):	no test
<b>additional_copy_info_flag</b> (acif):	no test
<b>PES_CRC_flag</b> (pescrf):	no test
<b>PES_extension_flag</b> (pesef):	no test
<b>PES_header_data_length</b> (phdl):	<ol style="list-style-type: none"> <li>1. test that phdl &gt;= sum of optional data fields ( &gt; for stuffing)</li> <li>2. test that phdl &lt;= 32</li> </ol>
'0010':	test that these four bits are really equal to '0010'
<b>marker bit</b> (mb):	test that (mb == 1) for all mb in the packet
<b>PTS</b> (pts):	no test
'0011':	test that these four bits are really equal to '0011'

Table C-3: Compliance for the PES packet header (Cont.)

Parameter	Error checking
'0001':	test that these four bits are really equal to '0001'
DTS (dts):	no test
reserved (r1):	test that (r1 == '11')
ESCR (escr):	no test
ES_rate (esr):	test that (esr != 0)
trick_mode_control (tmc):	no test
field_id (fid):	test that (fid != '11')
intra_slice_refresh (isr):	no test
frequency_truncation (ft):	no test
rep_cntrl (rc):	test that (rc != 0)
reserved (r2):	test that (r2 == '111')
reserved (r3):	test that (r3 == '11111')
additional_copy_info (aci):	no test
previous_PES_packet_CRC (pppc):	no test
PES_private_data_flag (pespdf):	no test
pack_header_field_flag (phfl):	no test
program_packet_sequence_counter_flag (ppscf):	no test
P-STD_buffer_flag (pstdbf):	no test
reserved (r4):	test that (r4 == '111')
PES_extension_flag_2 (pesef2):	no test
PES_private_data (ppd):	shall not emulate the packet_start_code_prefix (0x000001)
pack_field_length (pfl):	test that (pfl < pespl)
program_packet_sequence_counter (ppsc):	no test
MPEG1_MPEG2_identifier (mpeg1mpeg2i):	no test
original_stuff_length (osl):	if (mpeg1mpeg2i == 1) then test that (osl <= 16) else test that (osl <= 32)
'01':	test that these two bits are really equal to '01'
P-STD_buffer_scale (pstdbscale):	no test
P-STD_buffer_size (pstdbsize):	no test
PES_extension_field_length (pesefl):	test that (pesefl < pespl)
reserved (r5):	test that (r5 == '1111 1111') for all bytes
stuffing_byte (sb):	1. test that (sb == 0xFF) for all bytes 2. test that the number of sb <= 32 in PES packet header

**Table C-3: Compliance for the PES packet header (Cont.)**

Parameter	Error checking
PES_packet_data_byte (pespdb):	no test
padding_byte (pb):	test that (pb == 0xFF) for all bytes

## Compliance at the PSI level

The PSI level contains the following sections: PAT, PMT, CAT, NIT, and Private Sections.

**Table C-4: Compliance for the PAT sections**

Parameter	Error check
table_id (tid):	test that (tid == 0x00)
section_syntax_indicator (ssi):	test that (ssi == '1')
0 (zero):	test that (zero == '0')
reserved (res1):	test that (res1 == '11')
section_length (sl):	<ol style="list-style-type: none"> <li>test that (9 &lt;= sl &lt;= 1021)</li> <li>if (sl == n) then test that ((byte[n] == 0x00) or (byte[n] == 0xFF) or (byte[n] == 0x47)) and test that (byte[n-4] .. byte[n-1] == CRC32)</li> </ol> <p><b>NOTE:</b> use a C-type array notation, so byte[n] means the (n+1)th byte found after sl.</p>
transport_stream_id (tsid):	verify that tsid is the same for all sections with the same vn
reserved (res2):	test that (res2 == '11')
version_number (vn):	no test
current_next_indicator (cni):	no test
section_number (sn):	no test
last_section_number (lsn):	no test
program_number (pn):	does not take any single value more than once within all sections of a version
reserved (res3):	test that (res3 == '111')
network_PID (npid):	<ol style="list-style-type: none"> <li>test that npid is not in [0x000 .. 0x000F]</li> <li>test that (npid != 0x1FFF)</li> <li>test that npid is not a pid already used for audio or video</li> <li>test that npid is not a pid already used for data</li> </ol> <p><b>NOTE:</b> a npid can be the same as a pmpid.</p>

Table C-4: Compliance for the PAT sections (Cont.)

Parameter	Error check
program_map_PID (pmpid):	<ol style="list-style-type: none"> <li>test that pmpid is not in [0x000 .. 0x000F, 0x1FFF]</li> <li>test that pmpid is not a pid already used for audio, video</li> <li>test that pmpid is not a pid already used for data</li> </ol>
CRC32 (crc):	<ol style="list-style-type: none"> <li>test that the CRC value is correct</li> <li>test that the byte following the CRC is 0x00, 0x47 or 0xFF</li> </ol>

Table C-5: Compliance for the PMT sections

Parameter	Error check
table_id (tid):	test that (tid == 0x02)
section_syntax_indicator (ssi):	test that (ssi == '1')
'0' (zero):	test that (zero == '0')
reserved (res1):	test that (res1 == '11')
section_length (sl):	<ol style="list-style-type: none"> <li>test that (9 &lt;= sl &lt;= 1021)</li> <li>if (sl == n) then test that ((byte[n] == 0x00) or (byte[n] == 0xFF) or (byte[n] == 0x47)) and test that (byte[n-4] .. byte[n-1] == CRC32)</li> </ol> <p><b>NOTE:</b> use a C-type array notation, so byte[n] means the (n+1)th byte found after sl.</p>
program_number (pn):	<ol style="list-style-type: none"> <li>pn should be the one defined in PAT</li> <li>test that (pn != 0)</li> </ol>
reserved (res2):	test that (res2 == '11')
version_number (vn):	<ol style="list-style-type: none"> <li>if (cni == 1) then test that all sections have the same vn</li> <li>test that (v + 1) is the next version and has (cni == 1)</li> </ol>
current_next_indicator (cni):	no test
section_number (sn):	test that (sn == 0)
last_section_number (lsn):	test that (sn == 0)
reserved (res3):	test that (res3 == '111')
PCR_PID (pcrpid):	test that pcrpid is not in [0x0002 .. 0x000F]
reserved (res4):	test that (res4 == '1111')
program_info_length (pil):	<ol style="list-style-type: none"> <li>test that (pil &lt; 1024)</li> <li>test that (pil &lt; (sl - 9))</li> </ol>
descriptor:	see descriptor test (beginning on page C-12)
stream_type (st):	no test

**Table C-5: Compliance for the PMT sections (Cont.)**

Parameter	Error check
<b>reserved</b> (res5)	test that (res5 == '111')
<b>elementary_PID</b> (epid):	test that epid is not in [0x000 .. 0x000F, 0x1FFF]
<b>reserved</b> (res6):	test that (res6 == '1111')
<b>ES_info_length</b> (esil):	test that (esil < 1024)
<b>descriptor</b> :	see descriptor test (beginning on page C-12)
<b>CRC32</b> (crc):	<ol style="list-style-type: none"> <li>test that the CRC value is correct</li> <li>test that the byte following the CRC is 0x00, 0x47 or 0xFF</li> </ol>

**Table C-6: Compliance for the CAT section**

Parameter	Error check
<b>table_id</b> (tid):	test that (tid == 0x01)
<b>section_syntax_indicator</b> (ssi):	test that (ssi == '1')
<b>0</b> (zero):	test that (zero == '0')
<b>reserved</b> (res1):	test that (res1 == '11')
<b>section_length</b> (sl):	<ol style="list-style-type: none"> <li>test that (9 &lt;= sl &lt;= 1021)</li> <li><u>if</u> (sl == n)  <u>then</u> test that ((byte[n] == 0x00) <u>or</u> (byte[n] == 0xFF) <u>or</u> (byte[n] == 0x47))  <u>and</u> test that (byte[n-4] .. byte[n-1] == CRC32)</li> </ol> <p><b>NOTE:</b> use a C-type array notation, so byte[n] means the (n+1)th byte found after sl.</p>
<b>reserved</b> (res2):	test that (res2 == '1111 1111 1111 1111 11')
<b>version_number</b> (vn):	no test
<b>current_next_indicator</b> (cni):	no test
<b>section_number</b> (sn):	no test
<b>last_section_number</b> (lsn):	<ol style="list-style-type: none"> <li><u>if</u> (cni == 1) <u>then</u> test that all sections have the same vn</li> <li>test that (v + 1) is the next version and has (cni == 1)</li> </ol>
<b>descriptor</b> :	see descriptor test (beginning on page C-12)
<b>CRC32</b> (crc):	<ol style="list-style-type: none"> <li>test that the CRC value is correct</li> <li>test that the byte following the CRC is 0x00, 0x47 or 0xFF</li> </ol>

**Table C-7: Compliance for the NIT sections**

Parameter	Error check
<b>table_id</b> (tid):	test that tid not in [0x00 .. 0x3F]
<b>section_length</b> (sl):	no test

**Table C-8: Compliance for the private sections**

Parameter	Error check
<b>table_id</b> (tid):	test that tid is in [0x00 .. 0x3F]
<b>section_syntax_indicator</b> (ssi):	no test
<b>private_indicator</b> (pi):	no test
<b>reserved</b> (res1):	test that (res1 == '11')
<b>private_section_length</b> (sl):	no test
<b>table_id_extension</b> (tide):	no test
<b>reserved</b> (res2):	test that (res2 == '11')
<b>version_number</b> (vn):	no test
<b>current_next_indicator</b> (cni):	no test
<b>section_number</b> (sn):	no test
<b>last_section_number</b> (lsn):	<ol style="list-style-type: none"> <li>1. <u>if</u> (cni == 1) <u>then</u> test that all sections have the same vn</li> <li>2. test that (v + 1) is the next version and has (cni == 1)</li> </ol>
<b>CRC32</b> (crc)	test that the CRC value is correct

## Compliance for the Descriptors

This section covers the compliance testing for the descriptors. This list of descriptors tested includes: All (general), Video Stream, Audio Stream, Hierarchy, Registration, Data Stream Alignment, Target Background Grid, Video window, CA, ISO 636, System Clock, Multiplex Buffer Utilization, Copyright, Maximum Bitrate, Private Data, Smoothing Buffer, STD, and IBP.

**Table C-9: Compliance for all descriptors**

Parameter	Error check
<b>descriptor_tag</b> (dt):	test that dt not in [0, 1, 19 .. 63]
<b>descriptor_length</b> (dl):	<ol style="list-style-type: none"> <li>1. <u>if</u> descriptor is in CAT section <u>then</u> test that (sum of (dl + 1) == CAT.sl)</li> <li>2. <u>if</u> descriptor is in PMT section after the program_info_length field <u>then</u> test that (sum of (dl + 2) == PAT.pil)</li> <li>3. <u>if</u> descriptor is in PMT section after the ES_info_length field <u>then</u> test that (sum of (dl + 2) == PAT.esil)</li> </ol>
<b>CRC32</b> of the section	test that the CRC value is correct

The Video Stream Descriptor has descriptor\_tag == 2. It tests that the descriptor is at program and ES level and refers to video.

**Table C-10: Video stream descriptor**

Parameter	Error check
<b>descriptor_length</b> (dl):	test that (dl == mpeg1of * 2 + 1)
<b>multiple_frame_rate_flag</b> (mfrf):	no test
<b>frame_rate_code</b> (frc):	no frame_rate_code in SH > frc
<b>MPEG_1_only_flag</b> (mpeg1of):	<u>if</u> (mpeg1of == 0) <u>then</u> <ol style="list-style-type: none"> <li>1. descriptor_length = 3</li> <li>2. ES = MPEG2</li> <li>3. stream_type = 0x02</li> <li>4. stream_type : 0b1110 xxxx</li> <li>5. constrained_parameter_flag = 0</li> </ol> <u>else</u> <ol style="list-style-type: none"> <li>1. descriptor_length = 1</li> <li>2. ES = MPEG1</li> <li>3. stream_type = 0x01</li> <li>4. stream_type = 0b1110 xxxx</li> <li>5. constrained_parameter_flag = constrained_parameter_flag in the SH</li> </ol>
<b>constrained_parameter_flag</b> (cpf):	no test
<b>still_picture_flag</b> (spf):	no test



**Table C-10: Video stream descriptor (Cont.)**

Parameter	Error check
<b>profile_and_level_indication</b> (pali):	pali = profile_and_level_indication in the SHE
<b>chroma_format</b> (cf):	cf = chroma_format in the SHE
<b>frame_rate_extension_flag</b> (fref):	if (fref == 1) then frame_rate_extension_n != 0 and frame_rate_extension_d != 0
<b>reserved</b> (r):	test that (r == '1111')

The Audio Stream Descriptor is the descriptor with descriptor\_tag == 3. It tests that the descriptor is at program and ES level and refers to audio.

**Table C-11: Audio stream descriptor**

Parameter	Error check
<b>descriptor_length</b> (dl):	test that (dl == 1)
<b>free_format_flag</b> (fff):	if (fff == 1) then bitrate_index in AH = 0b0000 else bitrate_index in AH != 0b0000
<b>ID</b> (id):	id == ID in the AH
<b>layer</b> (l):	l = Layer in the AH
<b>variable_rate_audio_indicator</b> (vrai):	no test
<b>reserved</b> (r):	test that (r == '111')

Hierarchy Descriptor is the descriptor with descriptor\_tag == 4. Only MPEG-2 streams may have this descriptor.

**Table C-12: Hierarchy descriptor**

Parameter	Error check
<b>descriptor_length</b> (dl):	test that (dl == 4)
<b>reserved</b> (r1):	test that (r1 == '1111')
<b>hierarchy_type</b> (ht):	1. if (ht == 1, 2, 3, or 4) then video and ht = profile_and_level in SHE 2. if (ht == 5) then audio
<b>reserved</b> (r2):	test that (r2 == '11')
<b>hierarchy_layer_index</b> (hli):	no test
<b>reserved</b> (r3):	test that (r3 == '11')
<b>hierarchy_embedded_layer_index</b> (heli):	no test
<b>reserved</b> (r4):	test that (r4 == '11')
<b>hierarchy_channel</b> (hc):	no test

Registration Descriptor is the descriptor with descriptor\_tag == 5.

**Table C-13: Registration descriptor**

Parameter	Error check
descriptor_length (dl):	test that (dl >= 4)
format_identifier (fid):	no test
additional_identification_info (aII):	no test

Data Stream Alignment Descriptor is the descriptor with descriptor\_tag == 6. It is only available for video and audio streams.

**Table C-14: Data stream alignment descriptor**

Parameter	Error check
descriptor_length (dl):	test that (dl == 1)
alignment_type (at)	<ol style="list-style-type: none"> <li>1. <u>if</u> (at == 01, 02, 03 <u>or</u> 04) <u>then</u> <ol style="list-style-type: none"> <li>a. video</li> <li>b. data_alignment_indicator in PES header = 1</li> <li>c. test on the first PES_packet_data_byte</li> </ol> </li> <li>2. <u>if</u> (at == 01) <u>then</u> <ol style="list-style-type: none"> <li>a. audio</li> <li>b. data_alignment_indicator in PES header = 1</li> <li>c. the first PES_packet_data_byte = first byte of audio syncword</li> </ol> </li> <li>3. <u>if</u> (at == 01) <u>then</u> <ol style="list-style-type: none"> <li>a. video and audio</li> <li>b. data_alignment_indicator = 0</li> </ol> </li> </ol>

Target Background Grid Descriptor is the descriptor with descriptor\_tag == 7. It is only available for video streams.

**Table C-15: Target background grid descriptor**

Parameter	Error check
descriptor_length (dl):	test that (dl = 4)
horizontal_size (hs):	no test
vertical_size (vs):	no test
aspect_ratio_information (ari)	no test

Video Window Descriptor is the descriptor with descriptor\_tag == 8. It is only available for a video stream and the Target Background Grid Descriptor must also be present.

**Table C-16: Video window descriptor**

Parameter	Error check
<b>descriptor_length</b> (dl):	test that (dl == 4)
<b>horizontal_offset</b> (ho)	ho <= horizontal_size in the target background grid descriptor
<b>vertical_offset</b> (vo)	vo <= vertical_size in the target background grid descriptor
<b>window_priority</b> (wp):	no test

CA Descriptor is the descriptor with descriptor\_tag == 9. It is only available in PMT or CAT.

**Table C-17: CA descriptor**

Parameter	Error check
<b>descriptor_length</b> (dl):	test that (dl >= 4)
<b>CA_system_ID</b> (casid):	no test
<b>reserved</b> (r):	test that (reserved == '111')
<b>CA_PID</b> (capid):	capid != [0x0002, 0x000F] or 0x1FFF
<b>private_data_byte</b> (pdb):	no test

The ISO 639 Language Descriptor is the descriptor with descriptor\_tag == 10.

**Table C-18: ISO 639 language descriptor**

Parameter	Error check
<b>descriptor_length</b> (dl):	test that (dl % 4 == 0)
<b>ISO_639_language_code</b> (iso639lc)	no test
<b>audio_type</b> (at)	<ol style="list-style-type: none"> <li>1. <u>if</u> (at == 0xAA) then video</li> <li>2. <u>if</u> (at == 0xBB) or (at == 0xCC) then audio</li> </ol>

The System Clock Descriptor is the descriptor with `descriptor_tag == 11`. It is only available at the program level in a PMT.

**Table C-19: System clock descriptor**

Parameter	Error check
<b>descriptor_length</b> (dl):	test that (dl == 2)
<b>external_clock_reference_indicator</b> (ecri):	no test
<b>reserved</b> (r1):	test that (r1 == '1')
<b>clock_accuracy_integer</b> (cai):	no test
<b>clock_accuracy_exponent</b> (cae):	no test
<b>reserved</b> (r2):	test that (r2 == '11111')

The Multiplex Buffer Utilization Descriptor is the descriptor with `descriptor_tag == 12`.

**Table C-20: Multiplex buffer utilization descriptor**

Parameter	Error check
<b>descriptor_length</b> (dl):	test that (dl == 3)
<b>bound_valid_flag</b> (bvf):	no test
<b>LTW_offset_lower_bound</b> (ltwolb):	no test
<b>reserved</b> (r):	test that (r == '1')
<b>LTW_offset_upper_bound</b> (ltwoub):	no test

The Copyright Descriptor is the descriptor with `descriptor_tag == 13`.

**Table C-21: Copyright descriptor**

Parameter	Error check
<b>descriptor_length</b> (dl):	test that (dl >= 4)
<b>copyright_identifier</b> (ci):	no test
<b>additional_copyright_info</b> (aci):	no test

The Maximum Bitrate Descriptor is the descriptor with descriptor\_tag == 14. It is only available at the program or ES level.

**Table C-22: Maximum bitrate descriptor**

Parameter	Error check
descriptor_length (dl):	test that (dl == 3)
reserved (r):	test that (r == '11')
maximum_bitrate (mb):	no test

The Private Data Indicator Descriptor is identified by descriptor\_tag == 15.

**Table C-23: Private data indicator descriptor**

Parameter	Error check
descriptor_length (dl):	test that (dl == 4)
private_data_indicator (pdj):	no test

The Smoothing Buffer Descriptor is the descriptor with descriptor\_tag == 16.

**Table C-24: Smoothing buffer descriptor**

Parameter	Error check
descriptor_length (dl):	test that (dl == 6)
reserved (r1):	test that (r1 == '11')
sb_leak_rate (sblr):	no test
reserved (r2):	test that (r2 == '11')
sb_size (sbs):	no test

The STD Descriptor is the descriptor with descriptor\_tag == 17.

**Table C-25: STD descriptor**

Parameter	Error check
descriptor_length (dl):	test that (dl == 1)
reserved (r):	test that (r == '1111111')
leak_valid_flag (lvf):	no test

The IBP Descriptor is the descriptor with descriptor\_tag == 18.

**Table C-26: IBP descriptor**

Parameter	Error check
<b>descriptor_length</b> (dl):	test that (dl == 2)
<b>closed_gop_flag</b> (cgf):	no test
<b>identical_gop_flag</b> (igf):	no test
<b>max_gop_length</b> (mgl):	no test



# Glossary





# Glossary

---

*For information about the MPEG-2 standard, click the MPEG-2 help icon in the Tektronix MPEG Test System program group window.*

---



**ACTS (Advanced Communications Technologies and Services)**

A set of telecommunication research projects financed by the European Union.

**ARIB (Association of Radio Industries and Business)**

ARIB is a body of broadcasters, manufacturers, and communication carriers who are responsible for preparing standards on radio spectrum use in Japan.

**ASI**

Asynchronous Serial Interface, the DVB serial data protocol.

**ATSC (Advanced Television Systems Committee)**

The Advanced Television Systems Committee extended the MPEG standards to include HDTV.

**BAT (Bouquet Association Table)**

One of the tables defined by DVB-SI, the BAT provides information regarding bouquets (collections of services marketed as a single entity). DVB only.

**BIT (Broadcaster Information Table)**

ARIB only. The BIT provides broadcaster name and ID and descriptions of the services encoded in the transport stream for each broadcaster.

**CARB (Carte d'Acquisition / Restitution Binaire)**

(French for Binary Acquisition/Restitution Board) The MTS215 Data Store system, which can capture, store, and output MPEG-2 compliant transport streams.

**CAT (Conditional Access Table)**

One of the PSI tables described by the MPEG-2 standard, the CAT provides the association between one or more CA systems, their EMM (Entitlement Management Message) streams, and any special parameters associated with them.

**CRC (Cyclic Redundancy Check)**

One of the fields described in the MPEG-2 standard, used to verify the correctness of data in PSI and SI tables.

**DCT (Download Control Table)**

ARIB only. This table provides a list of available downloads encoded in the transport stream.

**DIT (Discontinuity Information Table)**

DVB table. This table is used with incomplete transport streams. The DIT is not broadcast.

**DLT (Download Table)**

ARIB only. This table is used when downloading software to set top boxes.

**DTA**

Deferred-time Analyzer.

**DTS (Decoding Time Stamp)**

One of the fields described in the MPEG-2 standard, may be present in a PES packet header that indicates the time that an access unit is decoded in the T-STD.

**DVB (Digital Video Broadcast)**

A project group of the European Broadcasting Union (EBU).

**DVB IRD (Digital Video Broadcasting Integrated Receiver Decoder)**

A receiving decoder that can automatically configure itself using the MPEG-2 Program Specific Information (PSI).

**DVB-MG**

Digital Video Broadcasting - Measurement Guidelines

**DVB-SI (Digital Video Broadcast Service Information)**

The DVB-SI adds the information that enables DVB IRDs to automatically tune to particular services and allows services to be grouped into categories with relevant schedule information. It has several tables, including: NIT, SDT, BAT, and EIT. (NIT is also required for MPEG-2.)

**ECM (Entitlement Control Message)**

Private conditional access information that specifies control words and possibly other, typically stream-specific, scrambling and/or control parameters.

**EISA (Extended Industry Standard Architecture)**

The PC bus used to communicate with the CARB and PIA boards.

**EIT (Event Information Table)**

One of the tables defined by DVB-SI, the EIT contains data concerning events (a grouping of elementary broadcast data streams with a defined start and end time belonging to a common service) and programs (a concatenation of one or more events under the control of a broadcaster, such as event name, start time, and duration).

**EMM (Entitlement Management Message)**

Private conditional access information that identifies the authorization levels or the services of specific decoders.

**EPG (Electronic Program Guide)**

The EPG gives the content of the current program.

**ETR (ETSI Technical Report)**

One of the types of documents released by ETSI.

**ETS (European Telecommunication Standard)**

One of the types of documents released by ETSI.

**ETSI**

European Telecommunications Standards Institute.

**Frame**

An ISDB-S/ARIB structure comprised of 48 slots. *See Slot and Super frame.*

**GA (Grand Alliance)**

This group is establishing the North American HDTV standards.

**IRD (Integrated Receiver / Decoder)**

A receiving decoder that can automatically configure itself using the MPEG-2 Program Specific Information (PSI).

**ISDB-S (Integrated Service Digital Broadcast Satellite)**

Standard adopted by ARIB describing the TMCC information used in satellite broadcast environments.

**ISO (International Standard Organization)**

Organization responsible for establishing standards at the world-wide level.

**Item**

The currently interpreted packet or section.

**M\_TMCC**

An ISDB-S/ARIB compliant multiplex with multiple transport streams. *See TMCC.*

**NIT (Network Information Table)**

One of the PSI tables described by the MPEG-2 standard and also one of the tables defined by DVB-SI. The NIT conveys information relating to the physical organization of the multiplex; that is, transport streams carried via a given network and the characteristics of the network itself. Transport streams are identified by the combination of an original network ID and a transport stream ID in the NIT.

**NVOD**

Near Video on Demand.

**OPCR (Original Program Clock Reference)**

Optional transport packet field defined in the MPEG-2 standard that contains a coded time stamp used in the reconstruction of a single program transport stream from another transport stream. The OPCR field shall be coded only in transport stream packets in which the PCR field is present.

**PAT (Program Association Table)**

One of the PSI tables described in the MPEG-2 standard, the PAT gives information about the structure of a transport stream.

**PCR (Program Clock Reference)**

One of the fields defined in the MPEG-2 standard, a time stamp in the transport stream from which decoder timing is derived.

**PES (Packetized Elementary Stream)**

A structure defined in the MPEG-2 standard used to carry elementary stream data.

**PID (Packet Identifier)**

One of the fields described in the MPEG-2 standard, a unique integer value used to identify elementary streams of a program in a single or multiprogram TS.

**PMT (Program Map Table)**

One of the PSI tables described by the MPEG-2 standard, the PMT identifies and indicates the locations of the streams that make up each service and the location of the Program Clock Reference (PCR) fields for a service. This table is transmitted in sections.

**PSI (Program Specific Information)**

A set of tables described by the MPEG-2 standard, the PSI contains all the tables that define the MPEG-2 transport stream. It consists of the PAT, PMT, CAT, and NIT tables. (NIT is also used for DVB-SI.)

**PSIP (Program and System Information Protocol)**

A set of tables defined by ATSC standards, provides information on services and events carried by different multiplexes and networks.

**PTS (Presentation Time Stamp)**

One of the fields described in the MPEG-2 standard, the PTS may be present in a PES packet header that indicates the time that a presentation unit is presented in the T-STD.

**RTA**

Real-time Analyzer.

**SDT (Service Description Table)**

The SDT contains data describing the services in the system. Examples include names of services and the service provider.

**SDTT (Software Download Trigger Table)**

ARIB only. This structure is used to define the service, group, and schedule for downloadable items encoded in the transport stream.

**SI (Service Information)**

Set of tables defined by DVB-SI, SI provides information on services and events carried by different Multiplexes, and even other networks. SI is structured in the following tables: PAT, NIT, CAT, SDT, EIT, TSDT, TDT, TOT, BAT.

**SIT (Selection Information Table)**

DVB-SI table. This table is used with incomplete transport streams. The SIT is not broadcast.

**Slot**

An ISDB-S/ARIB structure corresponding to one, 204-byte error coded packet. *See Frame and Super frame.*

**S\_TMCC**

An ISDB-S/ARIB compliant multiplex with only one transport stream. *See TMCC.*

**ST (Stuffing Table)**

One of the tables defined by DVB-SI, the ST provides stuffing sections.

**Super frame**

An ISDB-S/ARIB structure comprised of eight frames. *See Frame and Slot.*

**TDT (Time & Date Table)**

One of the tables defined by DVB-SI, the TDT carries the current time and date information.

**TMCC (Transmission and Multiplexing Configuration and Control)**

Information encoded in the first eight bytes of the 16-byte Reed-Solomon area of 204-byte packet transport streams. TMCC information includes modulation modes, slot assignments, and alarms.

**TOT (Time Offset Table)**

One of the tables defined by DVB-SI, the TOT gives information about a local time offset in a given area.

**TS (Transport Stream)**

A bit stream that contains 0 or more elementary streams combined in a manner that conforms to the MPEG-2 standard.

**T-STD (Transport Stream System Target Decoder)**

Described by the MPEG-2 standard, the T-STD is a hypothetical reference model of a decoding process used to define the semantics of a TS.





# Index





# Index

## A

- AAC audio elementary stream, icon, 2-14, 3-18
- Abort, 2-27, 3-13, A-1
- AC3 Identification in DVB Mode, Options menu selection, 3-68
- ACTS, definition, Glossary-1
- Address, Tektronix, xiii
- Analog TV virtual channels, icon, 3-22
- Analysis
  - automatic, system analyzer, 3-54
  - consistency check, 3-34
  - diffusion discontinuity, 3-90
  - diffusion hole, 3-88
  - diffusion rate, 3-84
  - dynamic, 3-47
  - EMM, 3-8, 3-82
  - LTW, 3-52
  - mega-frame, 3-46
  - menu, system analyzer, 2-9, 3-6
  - multiplex allocation, 3-30
  - multiplex rate, 3-29
  - PCR, 3-38
  - PID map, 3-31
  - PSI/SI rate, 3-37
  - PTS/DTS, 3-41
  - semantic, 3-45
  - smoothing buffer, 3-54
  - syntax, 3-33
  - T-STD, 3-48
- Analyzer Compliance Tests
  - descriptors, C-12
  - PES packet, C-6
  - PSI, C-8
  - transport stream, C-1
- Application
  - locked, A-1
  - window, system analyzer, 2-8, 3-3
- ARIB, definition, Glossary-1
- ASI, definition, Glossary-1
- ATSC, definition, Glossary-1
- ATSC PSIP selection, system analyzer, options menu, 3-68
- Audio elementary stream, icon, 2-14, 3-18
- Automatic analysis, system analyzer, 2-40, 3-54
  - options menu selection, 3-70

## B

- B Sync Byte
  - add only module, 3-98
  - removal, 3-103
- Base selection, system analyzer, options menu, 3-69
- BAT, definition, Glossary-1
- Bat, icon, 3-20
- Binary view, 2-23, 3-28
- BIT, definition, Glossary-1
- Buffer overflow, dynamic analysis, 2-30, 3-47
- Buffering simulation, 3-49
- Bytes, number in pattern, DVB channel coding and decoding, 3-104

## C

- C (virtual channels), icon, 3-22
- CA, 3-77
- CARB, definition, Glossary-1
- CAT
  - definition, Glossary-1
  - icon, 2-13, 3-17
- Chain
  - coding command, 3-98
  - decoding command, 3-103
- Change password, 1-3
- Check CRC command, system analyzer, 2-25, 2-28
- Coded block size, Reed-Solomon, 3-100
- Coding
  - convolutional interleaving, 3-108
  - DVB, 3-95
  - energy dispersal, 3-107
  - flow, 3-95
  - menu, DVB channel coding and decoding, 3-98
  - Reed-Solomon, 3-108
  - Viterbi, 3-109
- Compliance Tests
  - descriptors, C-12
    - audio stream, C-13
    - CA, C-15
    - copyright, C-16
    - data stream alignment, C-14
    - hierarchy, C-13
    - IBD, C-18

- ISO 639 language, C-15
- maximum bitrate, C-17
- multiplex buffer utilization, C-16
- private data indicator, C-17
- registration, C-14
- smoothing buffer, C-17
- STD, C-17
- system clock, C-16
- target background grid, C-14
- video stream, C-12
- video window, C-15
- PES, packet headers, C-6
- PSI sections
  - CAT, C-10
  - NIT, C-11
  - PAT, C-8
  - PMT, C-9
  - private, C-11
- transport stream
  - duplication packet, adaptation field, C-3
  - packet headers, C-1
- Composition motif, 3-105
- Computer requirements, 1-1
- Conditional access, 3-9
  - option, 3-77
- Configuration
  - default, 3-71
  - delete, 3-127
  - load (restore saved), 3-127
  - new (restore default Analysis Server configuration), 3-127
  - read default, 3-70
  - Reed-Solomon coding, 3-100
  - save, 3-126
  - save default, 3-70
- Configuration selections, system analyzer, options menu, 3-70
- Consistency check analysis, 3-34
- Contacting Tektronix, xiii
- Control words, fixed, 3-81
- Convolutional interleaving coding, 3-108
- CRC
  - analysis, 2-25
  - definition, Glossary-1
- CVct, icon, 3-21

## D

- Data, icon, 3-22
- Data elementary stream, icon, 2-14, 3-18
- DCT, definition, Glossary-1
- Decoding, DVB, 3-95

- Decoding menu, DVB channel coding and decoding, 3-102
- Default configuration, 3-71
- default configuration, restoring in the TMCC client, 3-127
- Deferred-time analysis, 2-1
- DeInterleaver, DVB channel coding and decoding, decoding command, 3-103
- Diffusion discontinuity analysis, 3-90
- Diffusion hole analysis, 3-88
- Diffusion rate, 3-84
- Digicipher II video elementary stream, icon, 2-14, 3-18
- Digital TV virtual channels, icon, 3-22
- Directories selection, system analyzer, options menu, 3-69
- DIT, definition, Glossary-2
- DLT, definition, Glossary-2
- Dolby digital audio elementary stream, icon, 2-14, 3-18
- Dongle. *See* Software key
- DSM CC (digital storage media command/control), icon, 2-14, 3-18
- DTA, definition, Glossary-2
- DTS, definition, Glossary-2
- Duration gauge, DVB channel coding and decoding, 3-96
- DVB
  - compliant files, 3-103
    - creating, 3-98
  - definition, Glossary-2
  - system analyzer, options menu, 3-68
- DVB Coding and Decoding
  - convolution interleaving, 3-108
  - introduction, 3-95
  - menus
    - coding, 3-98
    - decoding, 3-102
    - file, 3-97
    - generation, 3-104
    - help, 3-106
    - Reed-Solomon, 3-108
- DVB IRD, definition, Glossary-2
- DVB1-MG, definition, Glossary-2
- DVB-SI, definition, Glossary-2
- Dynamic analysis, 3-47

## E

- E (event), icon, 3-20, 3-22

- ECM
    - definition, Glossary-2
    - fixed, 3-81
    - icon, 2-14, 3-18
  - Edit menu, system analyzer, 2-9, 3-4
  - EISA, definition, Glossary-2
  - EIT
    - definition, Glossary-2
    - icon, 3-20, 3-21
  - Elementary stream, files, 2-3
    - FTP site, 2-4
  - EMM
    - definition, Glossary-2
    - icon, 2-14, 3-18
  - EMM analysis, 3-8, 3-82
  - End
    - command button, system analyzer, 3-13
    - locked application, A-1
    - task, A-1
  - Energy Dispersal
    - coding, 3-98, 3-107
    - coding command, 3-99
    - decoding command, 3-104
  - EPG, definition, Glossary-2
  - Error, command button, system analyzer, 3-13
  - error conditions in the syntax view, TMCC client, 3-116, 3-123
  - Escape key, 2-27, 3-13
  - ETR, definition, Glossary-3
  - ETS, definition, Glossary-3
  - ETSI, definition, Glossary-3
  - Ett, icon, 3-21
  - Exit
    - application, 1-8
    - system analyzer, 2-44
- F**
- Fields, system analyzer, interpreted view, 3-24
  - File
    - menu, system analyzer, 2-9
    - message window, 3-75
    - opening, 3-14
  - File Menu
    - DVB channel coding and decoding, 3-97
    - system analyzer, 3-3
  - file name indicator, TMCC Deferred Time client, 3-113
  - Filter, System Analyzer
    - apply, 3-63
    - define, 3-57
    - edit, 3-63
    - open, 3-62
    - save, 3-61
  - First-time operation, vii
  - Font selection, system analyzer, options menu, 3-69
  - frame, definition, Glossary-3
  - FTP site, elementary stream files, 2-4
- G**
- GA, definition, Glossary-3
  - General license password, 1-6, B-6
  - General password, 1-6
  - Generation menu, DVB channel coding and decoding, 3-104
  - GI-D Identification, Options menu selection, 3-68
  - Go To, command button, system analyzer, 3-13
  - green icons, TMCC client syntax view, 3-116, 3-123
- H**
- Hardware
    - installation, vii
    - requirements, 1-1
  - Help
    - menu, system analyzer, 2-9
    - obtaining MPEG-2 information, 2-7
  - Help icon, 3-113
  - Help menu
    - DVB channel coding and decoding, 3-106
    - system analyzer, 3-11
  - Hexadecimal view, 2-18, 3-25, 3-27
  - Hierarchic view, 2-1, 2-12, 3-15
  - Hierarchy view, command button, 3-12
- I**
- Icons
    - Analyzer hierarchic view, 3-17, 3-19, 3-21
    - Analyzer shortcut menus, 3-15
    - defined, 3-17, 3-19, 3-21, 3-73
  - Installation, hardware, vii
  - Interleaver
    - coding command, DVB channel coding and decoding, 3-101
    - file type required, 3-101
  - Interpretation selection, system analyzer, options menu, 3-70
  - Interpreted view, 2-2, 2-16, 3-23
    - analyzer, 3-16
  - Interrupt, 3-13
  - IRD, definition, Glossary-3

ISDB-S, definition, Glossary-3  
ISO, definition, Glossary-3  
Item, definition, Glossary-3  
Item number, system analyzer, interpreted view, 3-23

## K

Key, software, 1-6

## L

License, password, 1-6  
License manager, entering your password, 1-6, B-6  
Locked application, A-1  
Logging on, 1-3  
Lower toolbar, 2-10  
LTW analysis, 3-52

## M

M\_TMCC, definition, Glossary-3  
Manual reset, A-1  
Mega-frame analysis, 3-46  
Menu bar  
    DVB channel coding and decoding, 3-96  
    system analyzer, 3-3  
Message window, 2-42, 3-72  
    save, 3-72  
Messages, system analyzer, status bar, 2-10  
messages, displaying in the TMCC client, 3-124  
Mgt, icon, 3-21  
MIP, 3-46  
    icon, 2-14, 3-18  
MPEG-2  
    help, 2-7  
    selection, system analyzer, options menu, 3-68  
Multiplex allocation, 2-21, 3-30  
Multiplex analyses, 3-29  
Multiplex rate, 3-24, 3-29

## N

Next, command button, system analyzer, 3-13  
Next Error, command button, system analyzer, 2-17,  
    2-32  
NIT  
    definition, Glossary-3  
    icon, 2-13, 3-18, 3-19  
Number, command button, system analyzer, 3-13  
NVOD, definition, Glossary-3

## O

OPCR, definition, Glossary-3  
Open command, system analyzer, 2-11  
Open command button, system analyzer, 3-12  
Option CA, 3-9, 3-77  
Options menu, system analyzer, 2-9, 3-68  
Output messages in file, system analyzer, options menu  
    selection, 3-69

## P

Password, 1-3, B-6  
    and user name, Windows NT auto log on, 1-2  
    changing, emergency repair disk, 1-3  
    for installing software, 1-6  
    install, 1-6  
    reinstall, 1-6  
PAT  
    definition, Glossary-4  
    icon, 2-13, 3-17  
PAT icon, embedded commands, 2-24  
Pattern  
    composition motif, 3-105  
    generation command, DVB channel coding and  
        decoding, 3-104  
    repetition, 3-105  
PC2, 3-9, 3-78  
PC2 Dialog, menu, 2-9  
PCR, 2-28, 3-38  
    analysis, 2-28  
    definition, Glossary-4  
    icon, 2-13, 3-17  
    values, 2-29  
PES  
    definition, Glossary-4  
    icon, 2-13, 3-18  
    embedded commands, 2-32  
Phone number, Tektronix, xiii  
PID  
    8191, 2-21  
    definition, Glossary-4  
    icon, embedded commands, 2-22  
    map, 2-19, 3-31  
PMT  
    definition, Glossary-4  
    icon, 2-13, 3-18  
PMT icon, embedded commands, 2-26  
Position, interpreted view, 3-24  
Power switch, 1-2  
PRBS, 3-99, 3-107

Previous, command button, system analyzer, 3-13  
 Print message window, 3-75  
 Product support, contact information, xiii  
 Profile, saved Analysis Server configuration, 3-126  
 Protection, software key, 1-1  
 PSI, definition, Glossary-4  
 PSI/SI rate analysis, 3-37  
 PSIP  
   analysis functions, 3-1  
   coherence, 3-35  
   consistency check, 3-34  
   definition, Glossary-4  
   display hierarchic view, 3-5  
   display interpreted view, 3-5  
   filter, 3-56  
   hierarchic view, 3-20  
   rate analysis, 3-37  
   save table, 3-66  
   specify standard, 3-10, 3-12  
   view tables, 2-1  
 PTS, definition, Glossary-4  
 PTS/DTS analysis, 2-34, 3-41

## Q

Quit, system analyzer, 2-44

## R

Radio service, icon, 3-20  
 Radio virtual channels, icon, 3-22  
 red icons, TMCC client syntax view, 3-116, 3-123  
 Reed-Solomon  
   coding, 3-108  
   command, 3-100  
   configuration, 3-100  
   size of block, 3-100  
   decoding command, 3-104  
 Repair, software, B-1  
 Requirements, computer, 1-1  
 Reset, A-1  
 restore default analysis settings, 3-127  
 restoring defaults, TMCC client, 3-127  
 Rrt, icon, 3-22  
 RS(204, 188), 3-108  
 RTA, definition, Glossary-4

## S

S (service information), icon, 3-20  
 S\_TMCC, definition, Glossary-5

Satellite broadcasting, 3-95  
 Save  
   command button, system analyzer, 3-12  
   elementary streams, 3-2, 3-67  
   error messages in file, 3-69  
   filter, 3-61  
   interpreted view, 3-27  
   message window, 3-72  
   PES packets, 3-66  
   table sections, 3-66  
   transport packets, 3-65  
 saving configurations, in the TMCC client, 3-126  
 saving files, in the TMCC client, 3-125  
 SDT, definition, Glossary-4  
 Sdt, icon, 3-19  
 SDTT, definition, Glossary-4  
 Security, A-1  
 Selection menu, system analyzer, 2-9, 3-5  
 Semantic analysis, 3-45  
 Service support, contact information, xiii  
 setting probes, 3-121  
 Setup, hardware, vii  
 Shortcut menus, system analyzer, 2-15  
 Shutdown, 1-9, A-1  
 SI, definition, Glossary-4  
 SIT, definition, Glossary-5  
 Size of block, Reed-Solomon coding, 3-100  
 slot, definition, Glossary-5  
 slot configurations, displaying, 3-121  
 Smartcard reader, 3-77  
 Smoothing buffer analysis, 3-54  
 Software  
   key, 1-6  
   protection key, connecting to parallel port, 1-1  
   reinstall, B-1  
   repair, B-1  
 Software description, deferred-time analysis, 2-1  
 Software key, B-4  
 Software version, xii  
 Specifications, vii  
 ST, definition, Glossary-5  
 Standard, specify, 3-12  
 Start  
   command button, system analyzer, 3-13  
   system analyzer, application, 2-8  
 Starting, software installation, B-2  
 Status Bar  
   DVB channel coding and decoding, 3-96  
   system analyzer, 2-10, 3-13  
 Stt, icon, 3-22  
 Stuffing PID, 2-21  
 super frame, definition, Glossary-5

- Sync byte, 3-99
- sync bytes, TMCC probe, 3-128
- synchronization, TMCC Deferred Time Client, 3-111, 3-118
- Syntactic analysis, 3-33
- syntax analyses, displaying in the TMCC client, 3-122
- Syntax analysis, 2-26
- System Analyzer
  - (deferred-time analyzer), 3-1
  - help menu, 3-11

## T

- Task manager, A-1
- TDT, definition, Glossary-5
- Technical support, contact information, xiii
- Tektronix, contacting, xiii
- Teletext service, icon, 3-20
- Tests, analyzer compliance, C-1
- Time, interpreted view, 3-24
- Timing analysis, 3-38
- TMCC, definition, Glossary-5
- TMCC Configuration Client
  - analysis panel, 3-120
  - input panel, 3-119
- TMCC Deferred Time Client, setting probes, 3-121
- TMCC Deferred Time Client
  - display elements, 3-112
  - displaying messages, 3-124
  - displaying slot configurations, 3-121
  - displaying syntax, 3-122
  - LED icons, 3-116, 3-123
  - saving configurations, 3-126
  - saving files, 3-125
  - slots view, 3-113
  - specifying input, 3-119
  - starting, 3-118
  - synchronizing to a signal, 3-111, 3-118
  - syntax displayed, 3-115
  - syntax view, 3-114
  - toolbar icons, 3-113
- TMCC Expert Client, starting, 3-111
- TMCC Probes
  - alarm status notification, 3-129
  - descriptions, 3-128
  - frame size consistency, 3-129
  - modulation mode and slot consistency, 3-130
  - modulation order consistency, 3-131
  - number of slots consistency, 3-130
  - super frame size consistency, 3-129
  - overall stream rate, 3-128

- sync bytes, 3-128
- syntax, 3-130
- update consistency, 3-129
- update notification, 3-128
- Toolbar
  - system analyzer
    - lower, 2-10, 3-13
    - upper, 2-9, 3-12
  - TMCC client, 3-113
- TOT, definition, Glossary-5
- Transport packet, 2-22
  - DVB channel coding and decoding, generation command, 3-105
  - icon, 3-17
- Transport stream
  - icon, 3-17
  - open, 2-11
- TS
  - definition, Glossary-5
  - icon, 2-15, 3-17
- Ts, icon, 3-20, 3-22
- T-STD
  - analysis, 2-30, 3-48
  - definition, Glossary-5
- TV service, icon, 3-20
- TVct, icon, 3-21

## U

- Unscramble, 3-78, 3-79
- Unscrambling, 2-9
  - selection, system analyzer, options menu, 3-68
- Upper toolbar, 2-9
- URL, Tektronix, xiii
- user name and password, MTS300 test system auto log on, 1-2

## V

- Version, software, xii
- Viaccess, 3-80, 3-82
- Video elementary stream, icon, 2-14, 3-18
- View command button, system analyzer, 3-12
- Visual TSTD and LTW, system analyzer
  - mode, 3-47
  - options menu selection, 3-68
- Viterbi
  - coding, 3-109
  - command, 3-101
  - file type expected, 3-102

decoding, 3-101

## W

Web site address, Tektronix, xiii

Window

  application

    DVB channel coding and decoding, 3-96

    system analyzer, 2-8

  menu, system analyzer, 2-9

  message, 3-72

Windows NT

  initialization, 1-2, 1-3, 1-6

  security dialog box, A-1

